

SEP
23



 **REDROOM**
Heating Products

AFFORDABLE LUXURY WITH PRECISION ENGINEERING

WHY BUY A REDROOM RADIATOR?

- 5 year guarantee
- 2 year guarantee on electric radiators
- Steel made radiators
- Competitive prices
- Available in the most popular styles and sizes
- All outputs tested to European standard EN442
- High quality material and engineering
- All products are CE approved
- Dual Energy options

RANGE OVERVIEW

Redroom provide reliability and precision with every radiator. All Redroom radiators are manufactured in industry leading facilities using the highest quality materials and processes.



- 04** ELITE
- 06** ELITE ELECTRIC
- 08** OMNIA
- 12** TT
- 14** TT LUX
- 20** AZOR
- 24** BAXX
- 28** SUPERNOVAR
- 32** ELAN
- 38** ELAN ELECTRIC
- 42** ACCESSORIES
- 44** VALVES
- 48** DUAL ENERGY PACKS
- 49** HOW TO SPECIFY YOUR RADIATOR
- 50** UNDERFLOOR HEATING
- 54** THERMOSTAT CONTROLS

ELITE

Matt Black



NOW AVAILABLE IN CHIC MATT BLACK
The perfect radiator for a contemporary bathroom

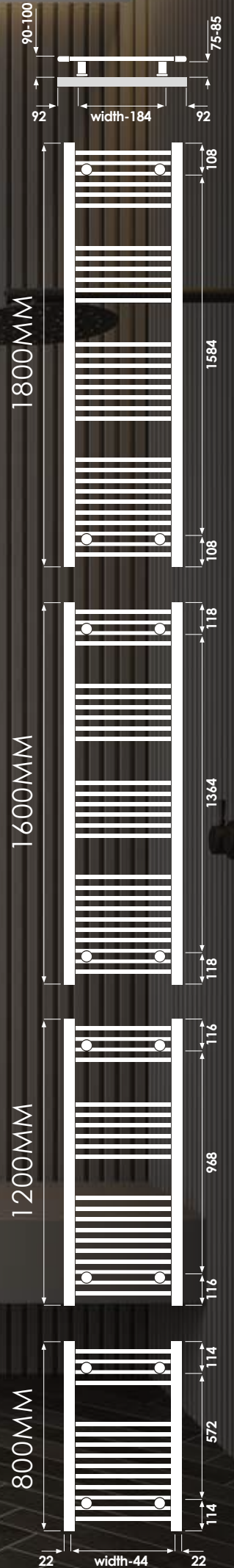

ELITE

ANTHRACITE / MATT BLACK

Code	Height (mm)	Width (mm)	Watts ΔT50	Dual Energy (optional)	BTU ΔT50	Price
ELT08004	800	400	283	200	966	£121.43
ELT08005	800	500	338	200	1153	£127.19
ELT08006	800	600	394	200	1344	£138.77
ELT12004	1200	400	402	300	1372	£165.72
ELT12005	1200	500	480	300	1638	£171.52
ELT12006	1200	600	557	400	1900	£181.14
ELT16005	1600	500	644	400	2197	£235.13
ELT16006	1600	600	755	500	2576	£244.98
ELT18005	1800	500	735	500	2508	£258.38
ELT18006	1800	600	854	600	2914	£268.46

Add colour code to the end of the code to specify colour: **Anthracite** 0346 | **Matt Black** 9205
Pipe centres from wall: 75-85mm | **Pipe centres:** 400mm Wide: 356mm, 500mm Wide: 456mm, 600mm Wide: 556mm



Anthracite

- ALSO AVAILABLE IN ELECTRIC SEE PAGE 7
- ACCESSORIES AVAILABLE SEE PAGE 42
- SEE PAGE 44 FOR CO-ORDINATING VALVES
- SEE PAGE 48 FOR DUAL ENERGY PACKS



ELITE ELECTRIC

Matt Black

ADJUSTABLE THERMOSTATIC CONTROLLER
 With multiple heating options for a perfect ambient temperature, day or night

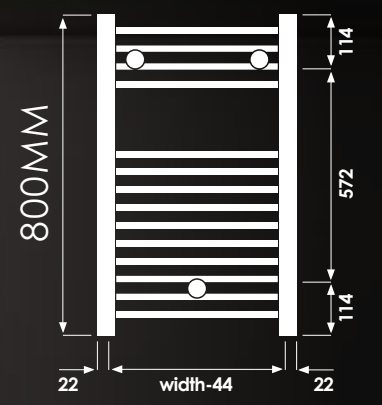
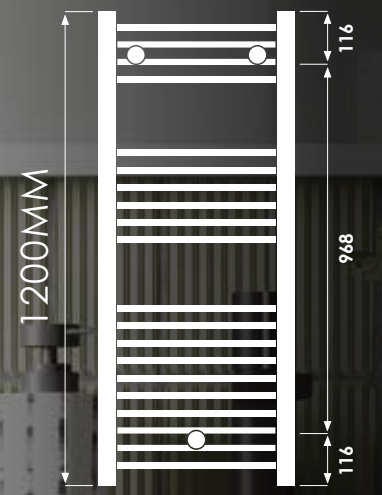
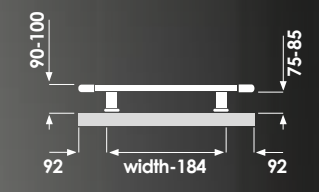

ELITE ELECTRIC



ADJUSTABLE THERMOSTAT CONTROLLER MATT BLACK

Code	Height (mm)	Width (mm)	Watts ΔT50	Price
ELTE08040MF9205	800	400	300	£326.34
ELTE12050MF9205	1200	500	750	£384.02
ELTE12060MF9205	1200	600	750	£394.62

For electric only. Not connected to hot water central heating systems.

OPERATING MODES

- COMFORT**
Set ambient temperature for daytime
- NIGHT**
Set the temperature lower for night
- 2 HOUR BOOST**
Heat bathroom rapidly or to quickly dry towels
- 7 DAY PROGRAMMER**
Set a daily or weekly heat program



Adjustable thermostatic controller

ACCESSORIES AVAILABLE SEE PAGE 42

OMNIA

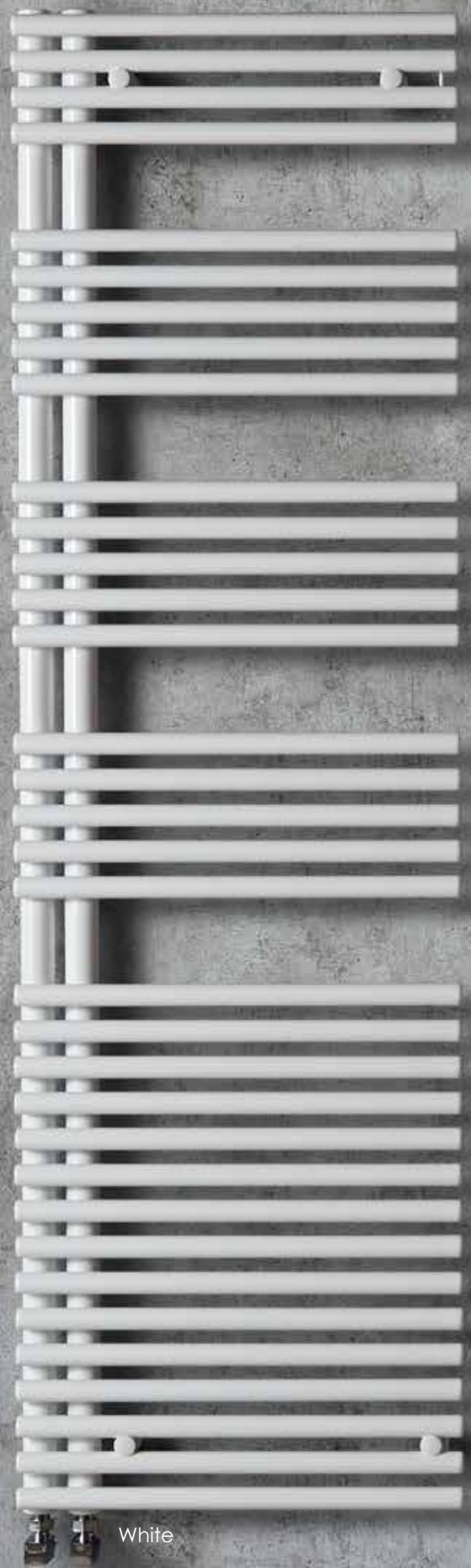

White

STYLISH AND FUNCTIONAL

As well as looking great, it is open at one side, making it easy to slip towels on and off

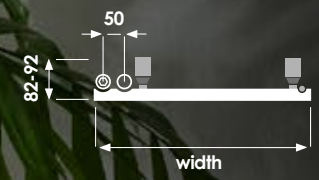
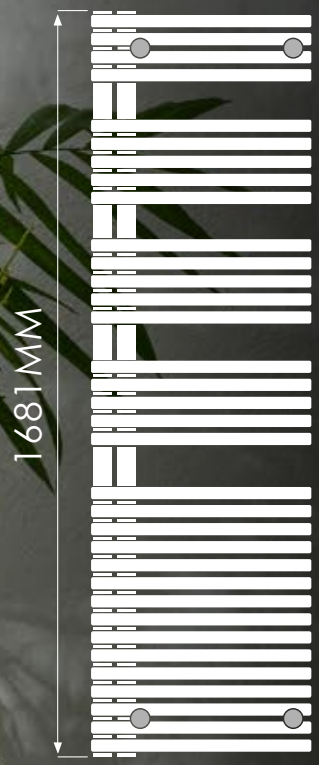

OMNIA

WHITE

Code	Height (mm)	Width (mm)	Watts ΔT50	Dual Energy (optional)	BTU ΔT50	Price
OMNIA - Left Hand						
OML120050	1161	496	547	400	1867	£345.61
OML120060	1161	596	628	400	2143	£368.23
OML170050	1681	496	778	500	2655	£415.36
OML170060	1681	596	894	600	3051	£449.87
OMNIA - Right Hand						
OMR120050	1161	496	547	400	1867	£345.61
OMR120060	1161	596	628	400	2143	£368.23
OMR170050	1681	496	778	500	2655	£415.36
OMR170060	1681	596	894	600	3051	£449.87

--- Pipe centres from wall: 41mm | Pipe centres: 50mm

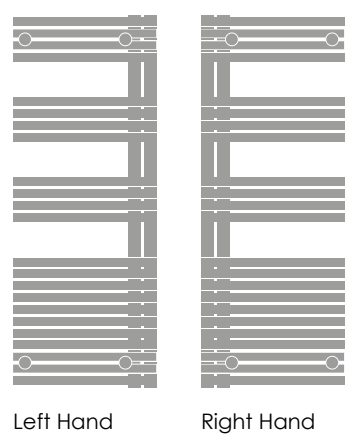

Left Hand Right Hand

ACCESSORIES AVAILABLE SEE PAGE 42

SEE PAGE 44 FOR CO-ORDINATING VALVES

SEE PAGE 48 FOR DUAL ENERGY PACKS

OMNIA



Quartz Beige

EASY TO SLIP TOWELS ON AND OFF

The Omnia is designed with both style and functionality in mind

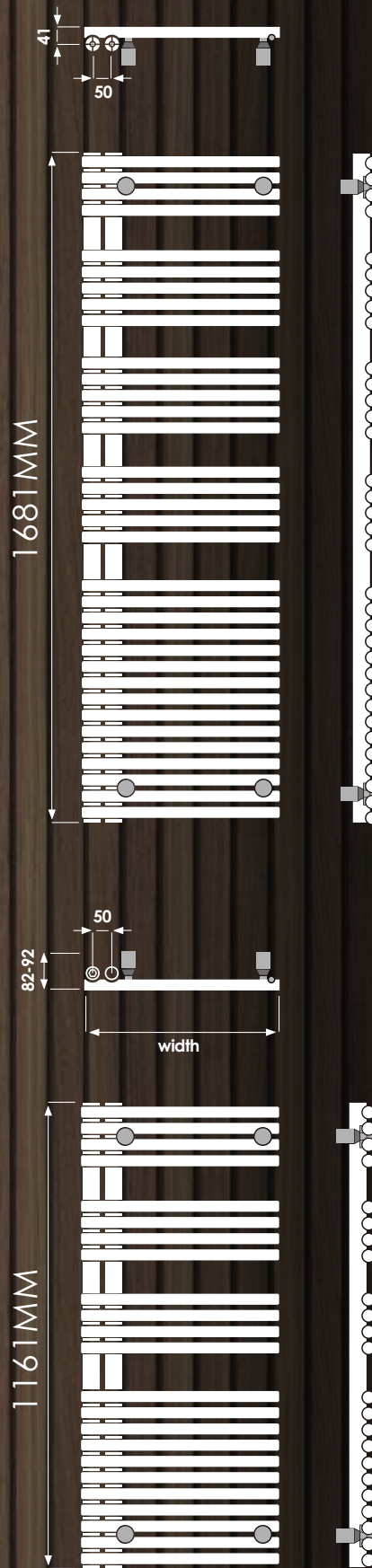

OMNIA

TITANE / QUARTZ BEIGE / ANTHRACITE / MATT BLACK

Code	Height (mm)	Width (mm)	Watts ΔT50	Dual Energy (optional)	BTU ΔT50	Price
OMNIA - Left Hand						
OML120050	1161	496	547	400	1867	£384.01
OML120060	1161	596	628	400	2143	£409.15
OML170050	1681	496	778	500	2655	£461.48
OML170060	1681	596	894	600	3051	£499.85
OMNIA - Right Hand						
OMR120050	1161	496	547	400	1867	£384.01
OMR120060	1161	596	628	400	2143	£409.15
OMR170050	1681	496	778	500	2655	£461.48
OMR170060	1681	596	894	600	3051	£499.85

Add colour code to the end of the code to specify colour: **Titane** 335 | **Quartz Beige** 523 | **Anthracite** 346 | **Matt Black** 0557

← Pipe centres from wall: 41mm | Pipe centres: 50mm

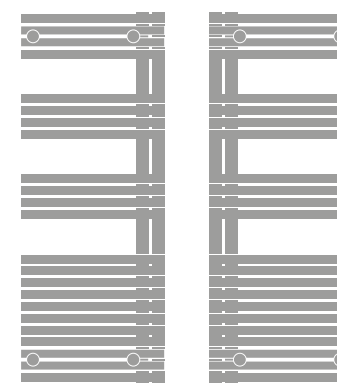

Left Hand

Right Hand

ACCESSORIES AVAILABLE SEE PAGE 42

SEE PAGE 44 FOR CO-ORDINATING VALVES

SEE PAGE 48 FOR DUAL ENERGY PACKS

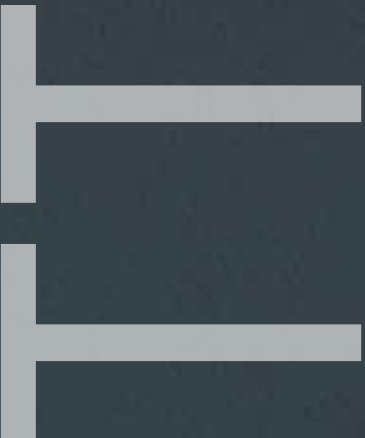

Titane

**EXCELLENT
STYLE AND
VALUE**

Available in three bold finishes to add the wow factor to any bathroom

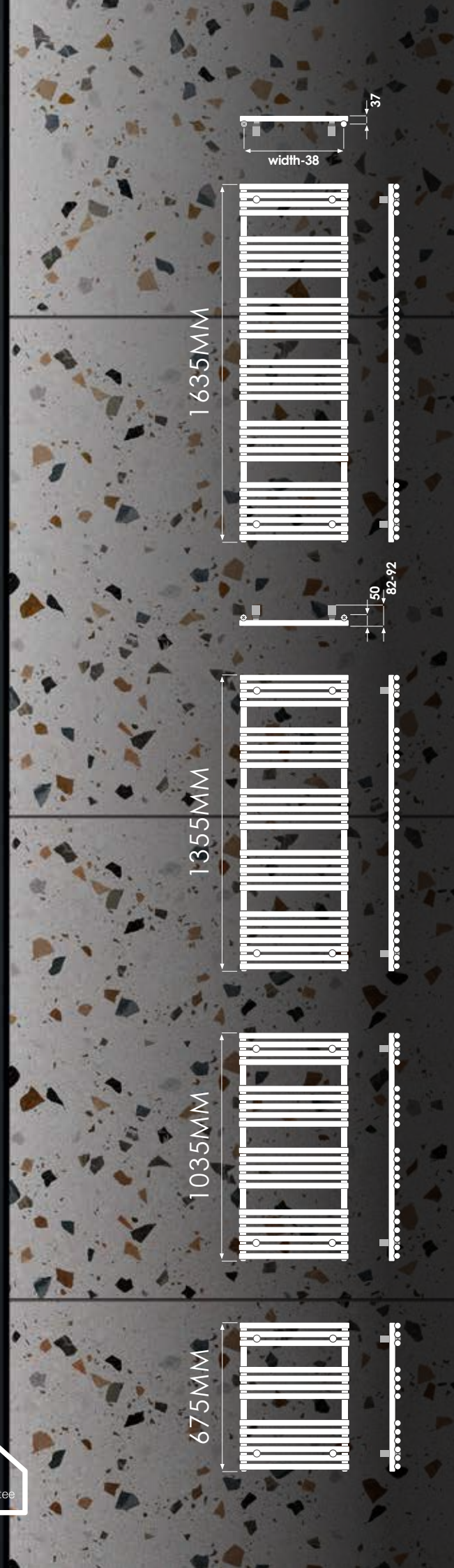

TT

TITANE / QUARTZ BEIGE / ANTHRACITE

Code	Height (mm)	Width (mm)	Watts ΔT50	Dual Energy (optional)	BTU ΔT50	Price
TT07005005	675	496	347	200	1183	£193.08
TT10005005	1035	496	518	300	1766	£228.43
TT14005005	1355	496	666	500	2271	£261.34
TT14006005	1355	596	786	500	2680	£285.96
TT16005005	1635	496	795	500	2710	£286.64
TT16006005	1635	596	938	600	3198	£316.66

Add colour code to the end of the code to specify colour: **Titane** 335 | **Quartz Beige** 523 | **Anthracite** 346

—|— Pipe centres from wall: 37mm | Pipe centres: 496mm Wide: 458mm, 596mm Wide: 558mm



Anthracite



Quartz Beige

ACCESSORIES AVAILABLE SEE PAGE 42

SEE PAGE 44 FOR CO-ORDINATING VALVES

SEE PAGE 48 FOR DUAL ENERGY PACKS

TT LUX



**FORM,
FUNCTION,
ULTRAMODERN
FINISH**
Now available in
glistening Quartz White

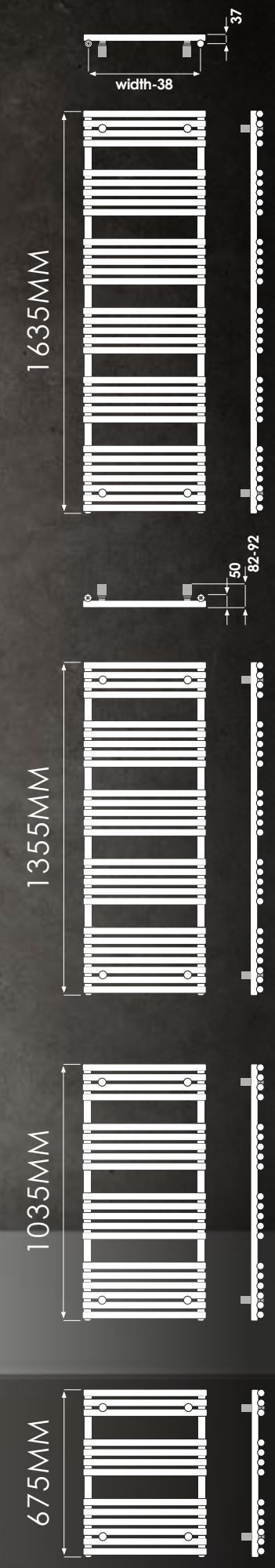

TT LUX

MATT BLACK / QUARTZ WHITE

Code	Height (mm)	Width (mm)	Watts ΔT50	Dual Energy (optional)	BTU ΔT50	Price
TTL07005005	675	496	347	200	1184	£208.52
TTL10005005	1035	496	518	300	1767	£246.71
TTL14005005	1355	496	666	500	2272	£282.23
TTL14006005	1355	596	786	500	2682	£308.83
TTL16005005	1635	496	795	500	2713	£309.60
TTL16006005	1635	596	938	600	3200	£341.99

Add colour code to the end of the code to specify colour: **Quartz White 521** | **Matt Black 557**
 Pipe centres from wall: 37mm | Pipe centres: 496mm Wide: 458mm, 596mm Wide: 558mm



ACCESSORIES AVAILABLE SEE PAGE 42

SEE PAGE 44 FOR CO-ORDINATING VALVES

SEE PAGE 48 FOR DUAL ENERGY PACKS

5 Year Guarantee RADIATORS

TT LUX



Gold Look

**BOLD STYLE,
EXCEPTIONAL
VALUE**

The TT Lux offers a
bespoke feel to any
bathroom

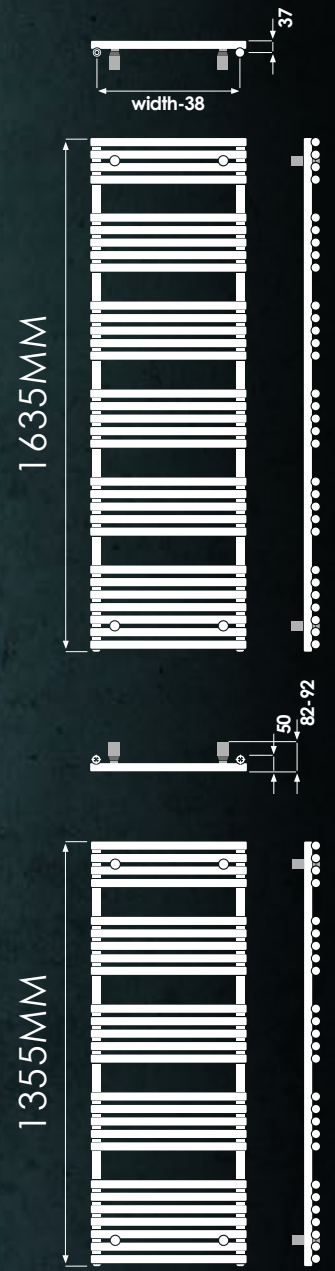

TT LUX

HAMMERED SILVER / GOLD LOOK

Code	Height (mm)	Width (mm)	Watts ΔT50	Dual Energy (optional)	BTU ΔT50	Price
TTL14005005	1355	496	666	500	2272	£282.23
TTL16005005	1635	496	795	600	2713	£309.60

Add colour code to the end of the code to specify colour: **Hammered Silver 422** | **Gold Look 514**

Pipe centres from wall: 37mm | Pipe centres: 496mm Wide: 458mm



ACCESSORIES
AVAILABLE
SEE PAGE 42

SEE PAGE 44 FOR
CO-ORDINATING
VALVES

SEE PAGE 48
FOR DUAL
ENERGY PACKS

TT LUX

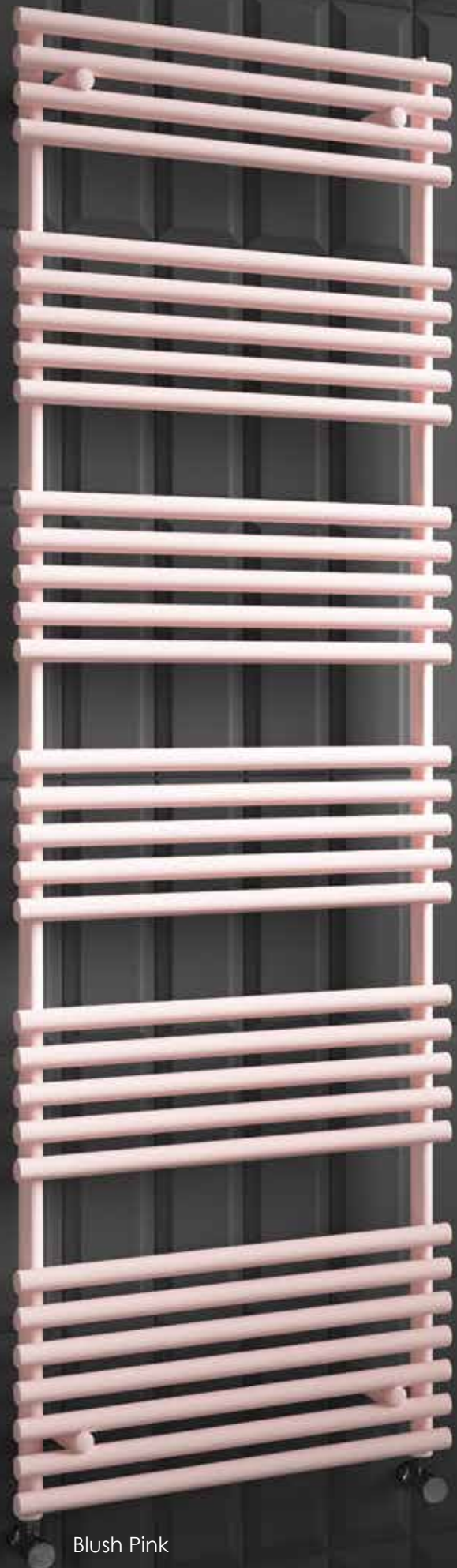

Blush Pink

DESIGNED TO BE THE FOCAL POINT

Trend led finish and contemporary design

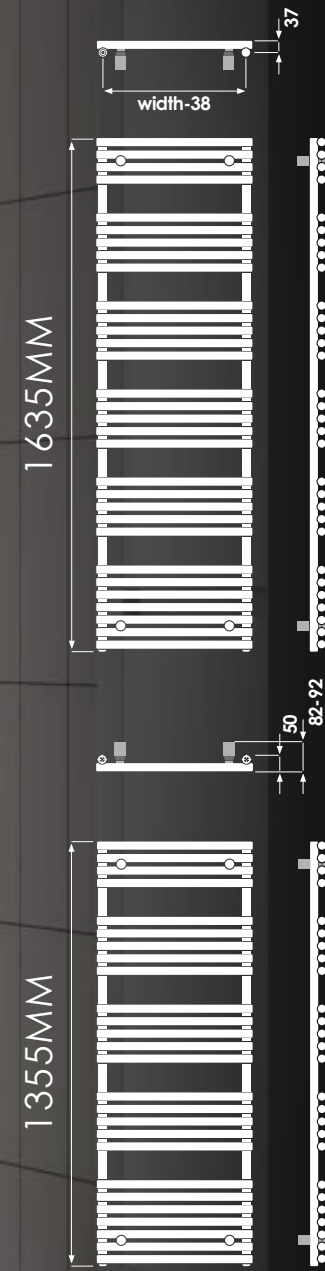

TT LUX

PACIFIC BLUE / BLUSH PINK

Code	Height (mm)	Width (mm)	Watts $\Delta T50$	Dual Energy (optional)	BTU $\Delta T50$	Price
TTL14005005	1355	496	666	500	2272	£282.23
TTL16005005	1635	795	600	2713	£309.60	

Add colour code to the end of the code to specify colour: **Pacific Blue** 519 | **Blush Pink** 168

Pipe centres from wall: 37mm | Pipe centres: 496mm Wide: 458mm



Pacific Blue

ACCESSORIES AVAILABLE SEE PAGE 42

SEE PAGE 44 FOR CO-ORDINATING VALVES

SEE PAGE 48 FOR DUAL ENERGY PACKS

AZOR



White

STYLISH AND MODERN

Excellent heat output due to larger surface area

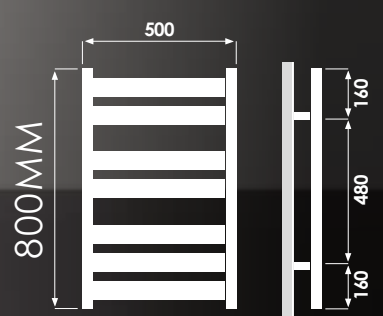
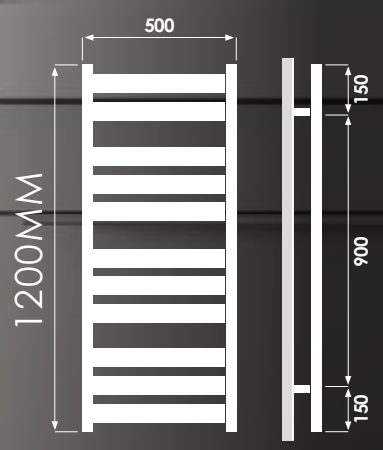
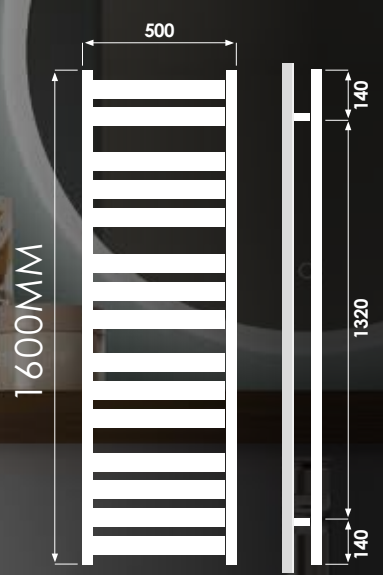
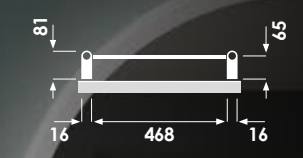

AZOR

WHITE

Code	Height (mm)	Width (mm)	Watts $\Delta T50$	Dual Energy (optional)	BTU $\Delta T50$	Price
AZO08050	800	500	324	200	1105	£276.07
AZO120050	1200	500	476	300	1624	£353.83
AZO160050	1600	500	647	500	2208	£481.60

--- Pipe centres from wall: 65mm | Pipe centres: 468mm | Finish: White

CHROME

Code	Height (mm)	Width (mm)	Watts $\Delta T50$	Dual Energy (optional)	BTU $\Delta T50$	Price
AZOC08050	800	500	203	100	689	£338.68
AZOC120050	1200	500	302	150	1034	£443.29
AZOC160050	1600	500	395	300	1344	£597.66

--- Pipe centres from wall: 65mm | Pipe centres: 468mm | Finish: Chrome



Chrome



ACCESSORIES AVAILABLE SEE PAGE 42

SEE PAGE 44 FOR CO-ORDINATING VALVES

SEE PAGE 48 FOR DUAL ENERGY PACKS

AZOR



**HIGHER HEAT
OUTPUT THAN
CHROME**

Providing you with
more warmth and
better heat efficiency

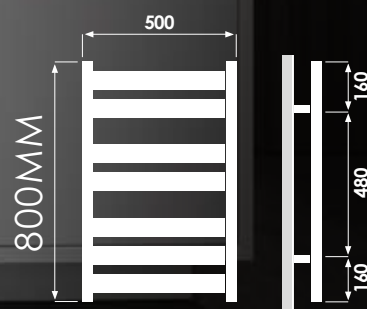
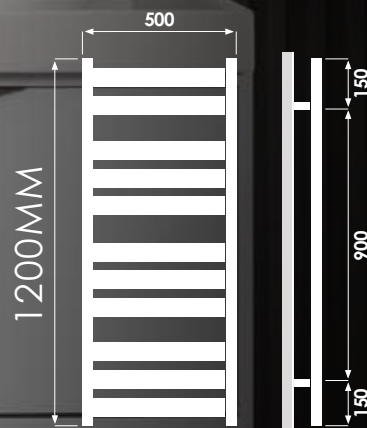
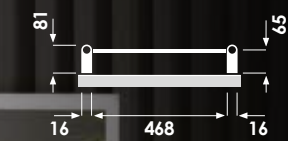

AZOR

ANTHRACITE

Code	Height (mm)	Width (mm)	Watts $\Delta T50$	Dual Energy (optional)	BTU $\Delta T50$	Price
AZO080050346	800	500	324	200	1105	£283.90
AZO120050346	1200	500	476	300	1624	£373.56
AZO160050346	1600	500	647	500	2208	£512.99

--- Pipe centres from wall: 65mm | Pipe centres: 468mm | Finish: Anthracite



ACCESSORIES
AVAILABLE
SEE PAGE 42

SEE PAGE 44 FOR
CO-ORDINATING
VALVES

SEE PAGE 48
FOR DUAL
ENERGY PACKS

BAXX



WOW FACTOR
 Square styling and bold design add the wow factor to your modern bathroom

5 Year Guarantee
 RADIATORS

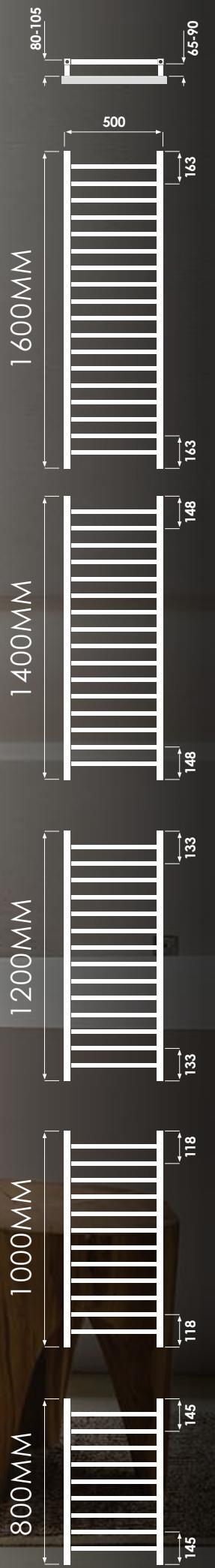

BAXX

CHROME

Code	Height (mm)	Width (mm)	Watts $\Delta T50$	Dual Energy (optional)	BTU $\Delta T50$	Price
BAXC080050	800	500	197	100	672	£323.76
BAXC100050	1000	500	249	150	850	£378.53
BAXC120050	1200	500	301	200	1027	£438.30
BAXC140050	1400	500	346	200	1181	£512.99
BAXC160050	1600	500	391	200	1334	£587.68

--- Pipe centres from wall: 65-90mm | Pipe centres: 470mm | Finish: Chrome



SQUARE VALVES LOOK GREAT WITH BAXX
 See page 46

SEE PAGE 44 FOR CO-ORDINATING VALVES

SEE PAGE 48 FOR DUAL ENERGY PACKS

BAXX



STUNNING RADIATOR
 Baxx Anthracite is the ideal choice for modern neutral colour schemes

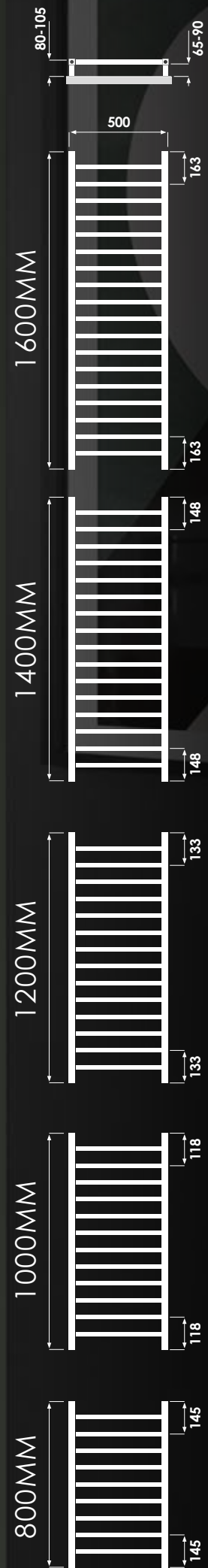

BAXX

ANTHRACITE

Code	Height (mm)	Width (mm)	Watts $\Delta T50$	Dual Energy (optional)	BTU $\Delta T50$	Price
BAX080050346	800	500	306	200	1044	£289.15
BAX100050346	1000	500	384	200	1310	£343.54
BAX120050346	1200	500	461	300	1573	£399.86
BAX140050346	1400	500	537	300	1832	£475.96
BAX160050346	1600	500	612	400	2088	£535.33

--- Pipe centres from wall: 65-90mm | Pipe centres: 470mm | Finish: Anthracite

SEE PAGE 44 FOR CO-ORDINATING VALVES

SEE PAGE 48 FOR DUAL ENERGY PACKS

SUPERNOVAR

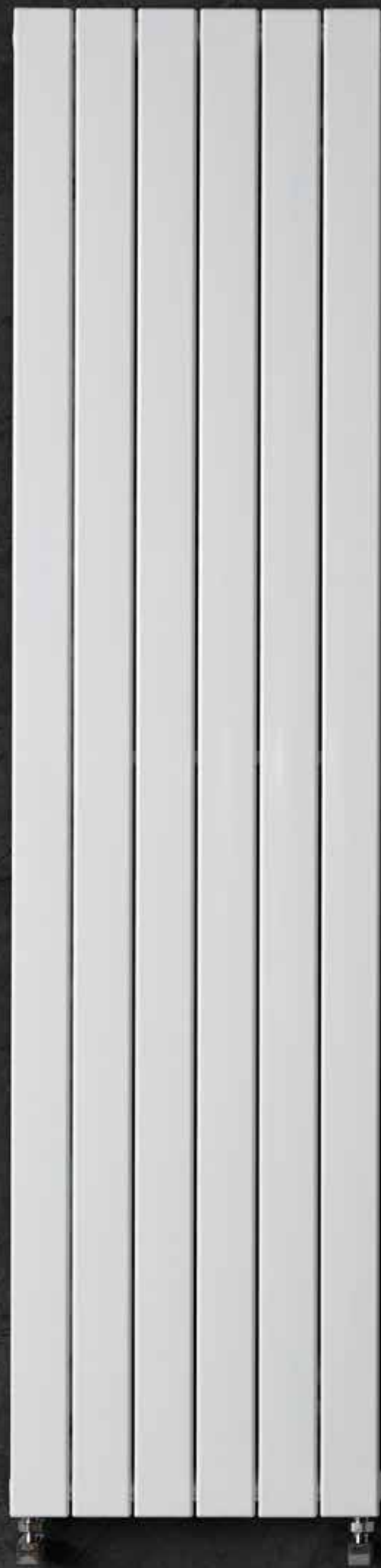

MODERN
SPACE
SAVING
STYLE

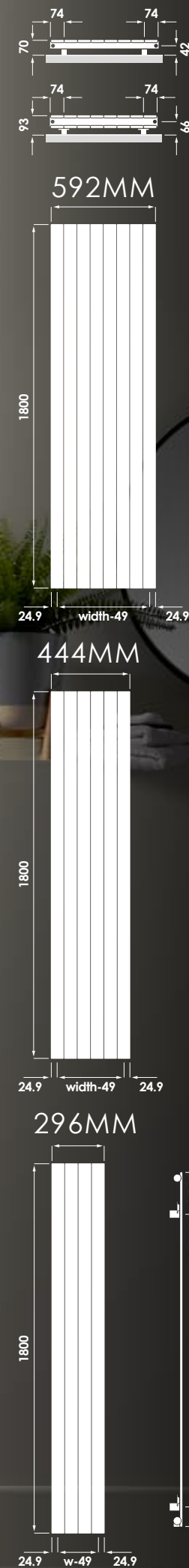

SUPERNOVAR VERTICAL

WHITE

Code	Height (mm)	Width (mm)	Watts ΔT50	BTU ΔT50	Price
Single Panel					
SNV180029	1800	296	568	1938	£344.00
SNV180044	1800	444	852	2907	£460.21
SNV180059	1800	592	1136	3876	£576.41
Double Panel					
SNVD180029	1800	296	836	2852	£556.51
SNVD180044	1800	444	1254	4279	£767.52
SNVD180059	1800	592	1672	5705	£978.49



ACCESSORIES
AVAILABLE
SEE PAGE 42

SEE PAGE 44 FOR
CO-ORDINATING
VALVES

SUPERNOVAR

MODERN
FUNCTIONAL
COLUMN
DESIGN

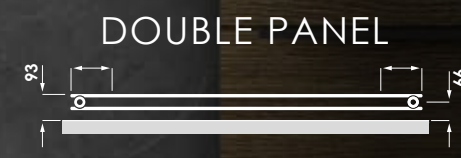

SINGLE
PANEL

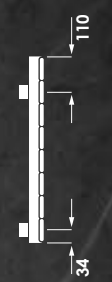

DOUBLE
PANEL



5 Year
Guarantee
RADIATORS

SUPERNOVAR HORIZONTAL

WHITE

Code	Height (mm)	Width (mm)	Watts $\Delta T50$	BTU $\Delta T50$	Price
Single Panel					
SNH059080	592	800	532	1815	£353.17
SNH059100	592	1000	665	2269	£392.92
SNH059120	592	1200	798	2723	£432.68
Double Panel					
SNHD059060	592	600	641	2187	£513.72
SNHD059080	592	800	855	2917	£580.98
SNHD059100	592	1000	1069	3647	£649.78
SNHD059120	592	1200	1283	4378	£718.57



Double panel

ACCESSORIES
AVAILABLE
SEE PAGE 42

SEE PAGE 44 FOR
CO-ORDINATING
VALVES

ELAN STRAIGHT

CHROME

Code	Height (mm)	Width (mm)	Watts ΔT50	Dual Energy (optional)	BTU ΔT50	Price
ELNC060040	600	400	151	100	515	£180.85
ELNC060080	600	800	280	100	955	£290.93
ELNC060100	600	1000	345	100	1177	£311.38
ELNC080040	800	400	177	100	604	£157.67
ELNC080050	800	500	218	150	744	£166.07
ELNC080060	800	600	258	150	880	£176.60
ELNC100050	1000	500	287	150	979	£223.31
ELNC120040	1200	400	260	200	887	£227.05
ELNC120050	1200	500	315	200	1075	£235.44
ELNC120060	1200	600	370	300	1262	£245.95
ELNC160030	1600	300	300	200	1024	£273.64
ELNC160050	1600	500	427	300	1457	£336.38
ELNC160060	1600	600	506	300	1726	£344.81
ELNC180030	1800	300	320	200	1092	£301.94
ELNC180050	1800	500	484	300	1651	£374.21
ELNC180060	1800	600	574	400	1958	£384.72
ELNC180075	1800	750	741	400	2527	£413.59

← Pipe centres from wall: 75-85mm | Pipe centres: 400mm Wide: 356mm / 500mm
Wide: 456mm / 600mm Wide: 556mm | Finish: Chrome

GOOD LOOKS

The Elan Straight's contemporary styling looks good in any bathroom

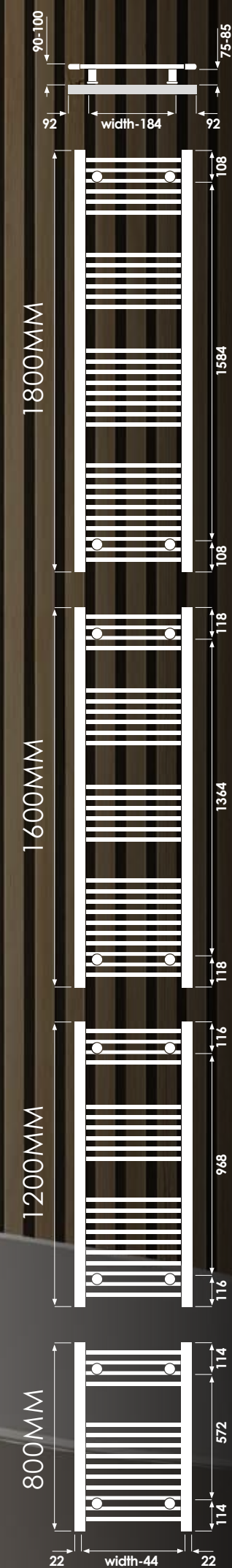

⚡ ALSO AVAILABLE IN ELECTRIC SEE PAGE 39

🔌 ACCESSORIES AVAILABLE SEE PAGE 42

🔧 SEE PAGE 44 FOR CO-ORDINATING VALVES

⚡💧 SEE PAGE 48 FOR DUAL ENERGY PACKS

ELAN

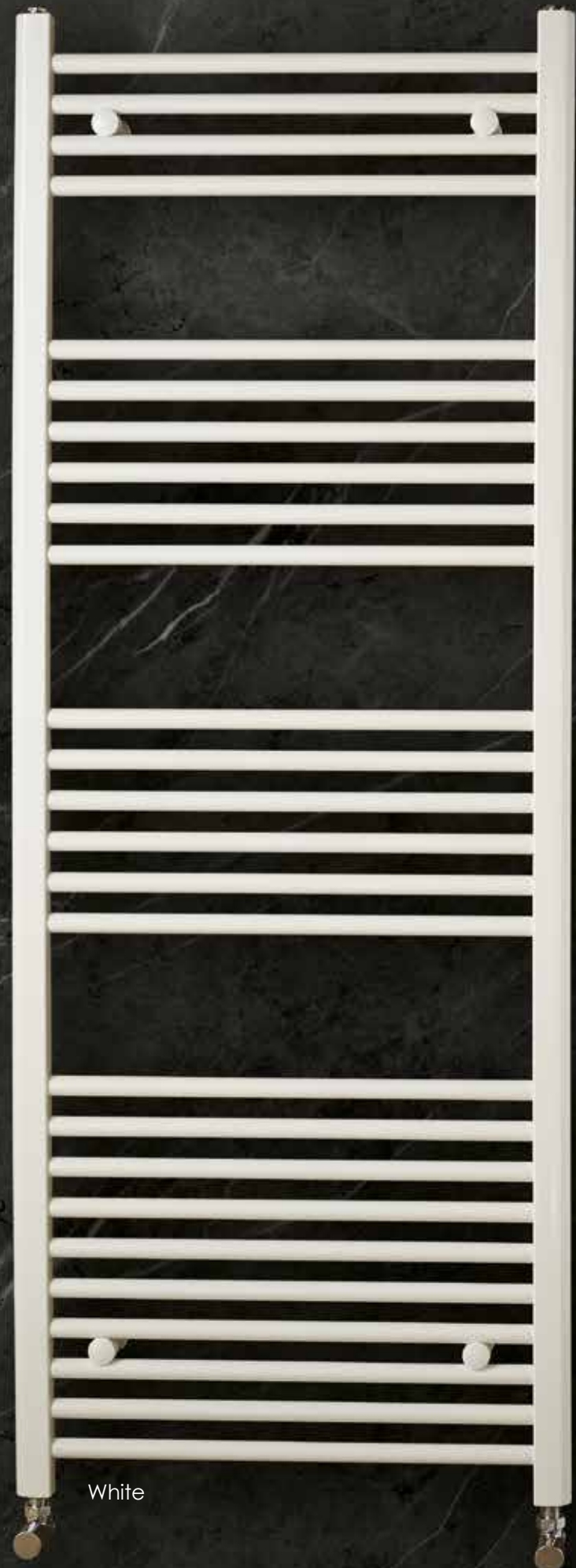

White

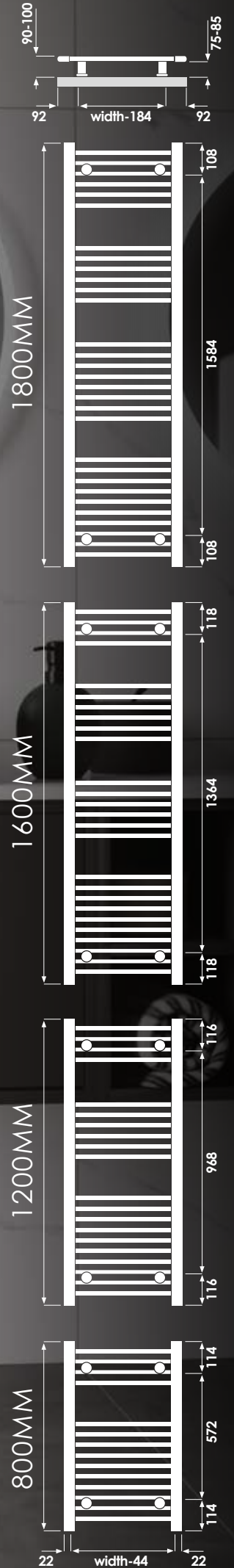
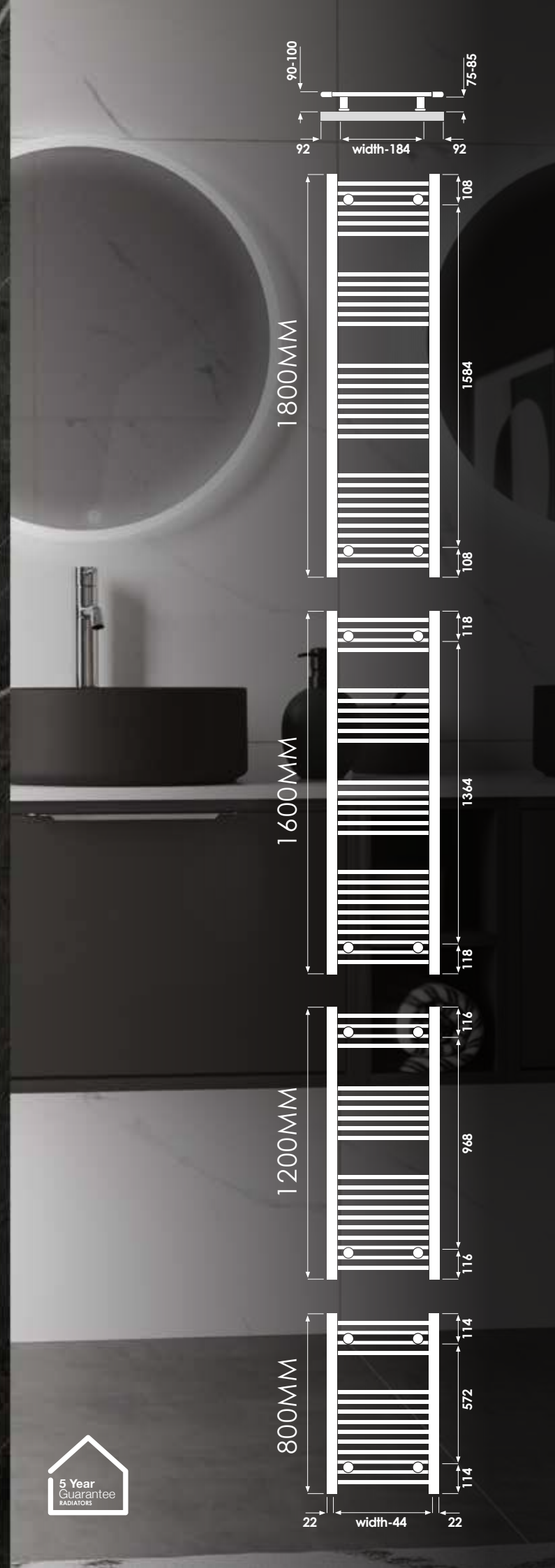

ELAN STRAIGHT

WHITE

Code	Height (mm)	Width (mm)	Watts ΔT50	Dual Energy (optional)	BTU ΔT50	Price
ELN080040	800	400	283	200	966	£132.44
ELN080050	800	500	338	200	1153	£138.77
ELN080060	800	600	394	200	1344	£151.38
ELN120040	1200	400	402	300	1372	£180.77
ELN120050	1200	500	480	300	1638	£187.12
ELN120060	1200	600	557	400	1900	£197.62
ELN160050	1600	500	644	400	2197	£256.50
ELN160060	1600	600	755	500	2576	£267.24
ELN180050	1800	500	735	500	2508	£281.88
ELN180060	1800	600	854	600	2914	£292.88

--- Pipe centres from wall: 75-85mm | Pipe centres: 400mm Wide: 356mm / 500mm
Wide: 456mm / 600mm Wide: 556mm | Finish: White

MORE WARMTH
White radiators give up to 30% more heat output than chrome



ACCESSORIES AVAILABLE SEE PAGE 42

SEE PAGE 44 FOR CO-ORDINATING VALVES

SEE PAGE 48 FOR DUAL ENERGY PACKS

ELAN CURVED



White

EXTRA SPACE

With slightly bowed rails, the Elan Curved in white and chrome offers extra space to hang your towels

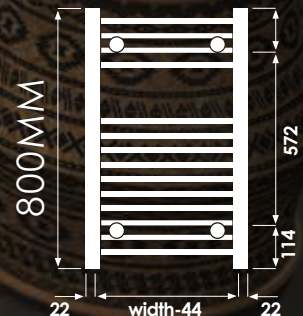
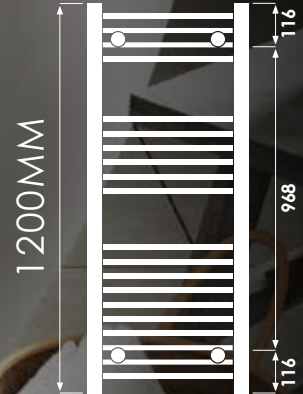
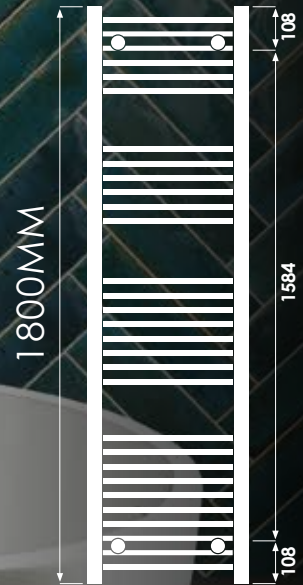
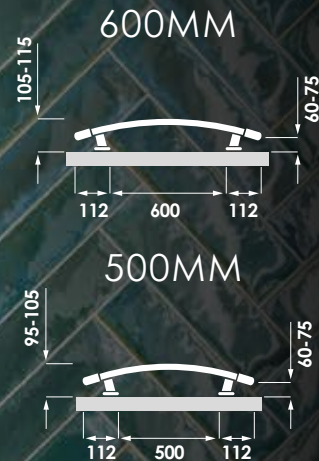

ELAN CURVED

WHITE

Code	Height (mm)	Width (mm)	Watts ΔT50	Dual Energy (optional)	BTU ΔT50	Price
ELNT080050	800	500	338	200	1153	£147.16
ELNT080060	800	600	394	200	1344	£157.67
ELNT120050	1200	500	490	300	1672	£195.50
ELNT120060	1200	600	557	400	1900	£206.04
ELNT180050	1800	500	725	500	2474	£290.11
ELNT180060	1800	600	854	600	2914	£300.65

← Pipe centres from wall: 60-75mm | Pipe centres: 500mm Wide: 456mm / 600mm
Wide: 556mm | Finish: White

CHROME

Code	Height (mm)	Width (mm)	Watts ΔT50	Dual Energy (optional)	BTU ΔT50	Price
ELNTC080050	800	500	218	150	744	£172.38
ELNTC080060	800	600	258	150	880	£182.89
ELNTC120050	1200	500	315	200	1075	£241.78
ELNTC120060	1200	600	370	200	1262	£252.26
ELNTC180050	1800	500	484	300	1651	£380.53
ELNTC180060	1800	600	574	400	1958	£393.11

← Pipe centres from wall: 60-75mm | Pipe centres: 500mm Wide: 456mm / 600mm
Wide: 556mm | Finish: Chrome



Chrome

ACCESSORIES AVAILABLE SEE PAGE 42

SEE PAGE 44 FOR CO-ORDINATING VALVES

SEE PAGE 48 FOR DUAL ENERGY PACKS

ELAN



ELECTRIC

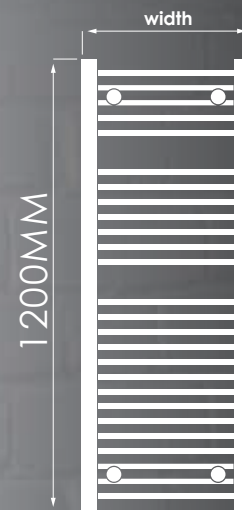

ADJUSTABLE THERMOSTATIC CONTROLLER

With multiple heating options for a perfect ambient temperature, day or night



ELAN ELECTRIC

IPX4 RATED

ADJUSTABLE THERMOSTAT CONTROLLER CHROME

Code	Height (mm)	Width (mm)	Watts $\Delta T50$	Price
ELNEC12050MF	1200	500	300	£580.27
ELNEC12060MF	1200	600	400	£596.00

For electric only. Not connected to hot water central heating systems.

OPERATING MODES



COMFORT
Set ambient temperature for daytime



NIGHT
Set the temperature lower for night



2 HOUR BOOST
Heat bathroom rapidly or to quickly dry towels



7 DAY PROGRAMMER
Set a daily or weekly heat program



ACCESSORIES AVAILABLE SEE PAGE 42



ELECTRIC

PERFECT FOR THE MODERN HOME

Easy to install, energy efficient and can heat your towels when your central heating is off

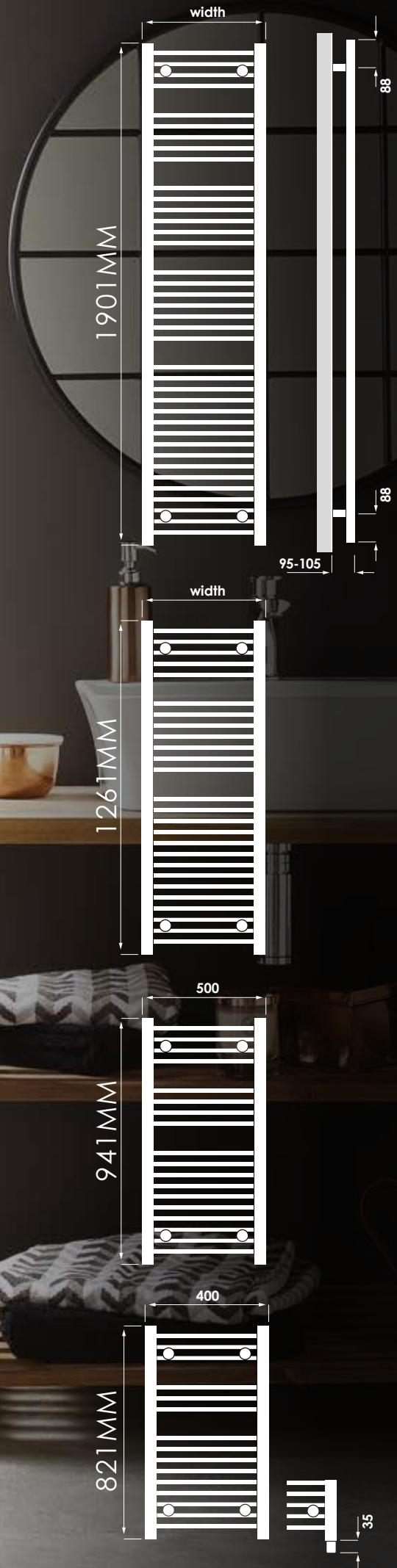

ELAN ELECTRIC

SIMPLE IMMERSION HEATER CHROME

Code	Height (mm)	Width (mm)	Watts $\Delta T50$	Price
ELNEC08040F	821	400	150	£416.12
ELNEC09050F	941	500	200	£425.75
ELNEC12050F	1261	500	200	£500.90
ELNEC12060F	1261	600	300	£506.71
ELNEC18050F	1901	500	400	£624.19
ELNEC18060F	1901	600	500	£632.80

ACCESSORIES AVAILABLE SEE PAGE 42



PRACTICAL
SOLUTIONS
THAT LOOK
GREAT TOO



Handy Magnetic Towel Rail
HDY1C 380mm (Overall length 440mm) Chrome **£119.81**
Max weight capacity 5KG



Hooky Towel Hook
HOO3C Suitable for Elite & Elan Chrome **£16.22**



Hangy Magnetic Towel Hook
HAG2C Chrome **£36.19**
Max weight capacity 3KG



Hangy Clamp Fixing Towel Hook
HAG1C Chrome **£13.73**

S
E

V

A



MATCH
YOUR VALVES
TO YOUR
RADIATOR



VALVES



MANUAL RADIATOR VALVES 15MM



Angled Round Valve Pack
RRV1C Chrome **£28.56**



Straight Round Valve Pack
RRV2C Chrome **£28.56**



Corner Round Valve Pack
RRV3C Chrome **£49.32**



Chrome



Angled Round Valve Pack
RRV1A Anthracite **£31.15**



Straight Round Valve Pack
RRV2A Anthracite **£31.15**



Corner Round Valve Pack
RRV3A Anthracite **£51.91**



Anthracite



Angled Round Valve Pack
RRV1B Black **£31.15**



Straight Round Valve Pack
RRV2B Black **£31.15**



Corner Round Valve Pack
RRV3B Black **£51.91**



Black



Angled Round Valve Pack
RRV1V Volcanic **£31.15**



Straight Round Valve Pack
RRV2V Volcanic **£31.15**



Corner Round Valve Pack
RRV3V Volcanic **£51.91**



Volcanic



Angled Round Valve Pack
RRV1W White **£31.15**



Straight Round Valve Pack
RRV2W White **£31.15**



Corner Round Valve Pack
RRV3W White **£51.91**



White



Angled Round Valve Pack
RRV1N Brushed Nickel **£43.04**



Straight Round Valve Pack
RRV2N Brushed Nickel **£43.04**



Corner Round Valve Pack
RRV3N Brushed Nickel **£60.52**



Brushed Nickel

Colour keys are for guidance only and are not representative of the actual colour.

SQUARE MANUAL RADIATOR VALVES 15MM



Angled Square Valve Pack
RRV4C Chrome **£50.62**



Straight Square Valve Pack
RRV5C Chrome **£50.62**



Corner Square Valve Pack
RRV6C Chrome **£64.90**

SQUARE
VALVES LOOK
GREAT WITH
BAXX AND
SUPERNOVAR

THERMOSTATIC RADIATOR VALVES 15MM



Angled Thermostatic Valve Pack
RRV7C Chrome **£72.68**



Straight Thermostatic Valve Pack
RRV8C Chrome **£72.68**



Corner Thermostatic Valve Pack
RRV9C Chrome **£72.88**



Chrome

PERIOD STYLE THERMOSTATIC RADIATOR VALVES 15MM



Classic Angled Thermostatic Valve Pack
RRCLV1C Chrome **£82.14**



Classic Angled Thermostatic Valve Pack
RRCLV1SN Satin Nickel **£82.14**



Classic Angled Thermostatic Valve Pack
RRCLV1AB Antique Brass **£98.58**



Classic Angled Thermostatic Valve Pack
RRCLV1C Copper **£108.56**



Traditional Straight Thermostatic Valve Pack
RRT1C Chrome **£102.95**



Traditional Straight Thermostatic Valve Pack
RRT1N Nickel **£102.95**



Traditional Straight Thermostatic Valve Pack
RRT1B Antique Brass **£102.95**



Traditional Straight Thermostatic Valve Pack
RRT1CO Copper **£109.19**



Angled Thermostatic Valve Pack
RRV7B Black **£75.28**



Straight Thermostatic Valve Pack
RRV8B Black **£75.28**



Corner Thermostatic Valve Pack
RRV9B Black **£77.88**



Black



Angled Thermostatic Valve Pack
RRV7V Volcanic **£75.28**



Straight Thermostatic Valve Pack
RRV8V Volcanic **£77.88**



Corner Thermostatic Valve Pack
RRV9V Volcanic **£77.88**



Volcanic



Angled Thermostatic Valve Pack
RRV7W White **£75.28**



Straight Thermostatic Valve Pack
RRV8W White **£77.88**



Corner Thermostatic Valve Pack
RRV9W White **£77.88**



White

ACCESSORIES



300mm 15mm Pipe and Rosettes
RRP1 Chrome **£19.46**



180mm Black 15mm Pipe and Rosettes
RRP1B Black **£24.34**



Angled Thermostatic Valve Pack
RRV7N Nickel **£80.48**

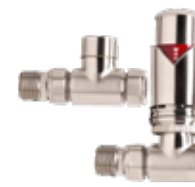

Straight Thermostatic Valve Pack
RRV8N Nickel **£80.48**



Corner Thermostatic Valve Pack
RRV9N Nickel **£77.88**



Brushed Nickel

Colour keys are for guidance only and are not representative of the actual colour.



DUAL ENERGY PACKS

Do you still want to warm your towels even when the central heating is turned off?

You can add one of these great dual energy packs to your radiator to allow you to control it electrically when the central heating is off.

Code		Description	Price
DEPACK100	100W	Element length 300mm	£196.80
DEPACK150	150W	Element length 300mm	£196.80
DEPACK200	200W	Element length 340mm	£196.80
DEPACK300	300W	Element length 400mm	£196.80
DEPACK400	400W	Element length 500mm	£196.80
DEPACK500	500W	Element length 580mm	£196.80
DEPACK600	600W	Element length 650mm	£196.80



THE DEPACK IS BARELY VISIBLE WHEN FITTED

All Redroom radiators have the CE mark, having been independently tested in accredited laboratories to EN442 in accordance with CE requirements. This means our published heat output figures are fully in line with the testing criteria. You can therefore specify the size of your radiator with the assurance that your choice will perform as stated, making Redroom radiators the obvious choice.

HOW TO SPECIFY YOUR RADIATOR



STEP 1



STEP 2



STEP 3



SECONDARY HEAT SOURCE

HOW?

1. Turn off connection to central heating, so the water within the radiator is isolated
2. Switch on Depack, so your radiator will be heated electrically
3. Enjoy warm towels all year long even when the central heating is off

To start with, you need to find out the heat requirement of the room in Watts. To calculate this as a rough guide, allow 50 watts per cubic metre of the room. You should also consult with a heating engineer for the exact requirement. To change the watts into BTUs, multiply the watt amount by 3.412.

Choose the location of the radiator and figure out any restrictions that could occur, for example height if the radiator is going to be fitted under a window.

Browse through this catalogue and choose the perfect radiator for your dream bathroom. For more information speak to your local retailer or heating engineer.

Does your radiator meet the room's heat requirement?

Depending on the size of your bathroom and type of radiator you want, you may need a secondary heat source.

If necessary you can add an extra radiator or underfloor heating to make sure your room is sufficiently heated.



UNDERFLOOR HEATING

Add luxurious comfort to your home with Redroom underfloor heating. Perfect for heating all areas of your house, but particularly suited to kitchens and bathrooms.

All mats are installed with a choice of three stylish digital thermostats that have energy saving functions to help reduce heating costs.

Available in a range of sizes, the self-adhesive mesh can easily and quickly be fitted directly onto concrete or insulation boards to provide an even spread of heat.



ENERGY EFFICIENCY

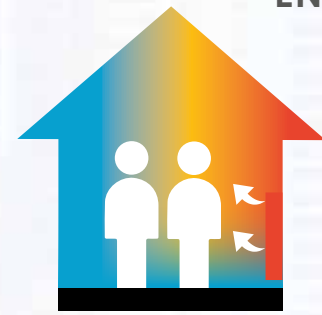

Radiators generate warmth around and above the radiator

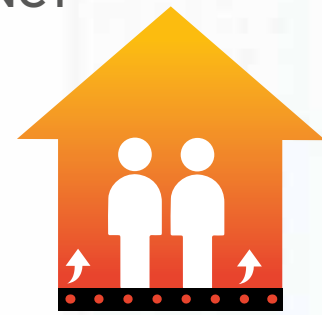

Underfloor heating provides the ultimate comfort with heat rising up from the floor where you need it the most

100W UNDERFLOOR HEATING MATS

Code	Description	Price
UHF1	1.0m ² 100W	£90.31
UHF15	1.5m ² 150W	£98.21
UHF2	2.0m ² 200W	£116.46
UHF25	2.5m ² 250W	£138.67
UHF3	3.0m ² 300W	£174.68
UHF35	3.5m ² 350W	£187.70
UHF4	4.0m ² 400W	£211.45
UHF5	5.0m ² 500W	£264.34
UHF6	6.0m ² 600W	£317.21
UHF7	7.0m ² 700W	£370.06
UHF8	8.0m ² 800W	£422.94
UHF9	9.0m ² 900W	£448.07
UHF10	10m ² 1000W	£489.40
UHF12	12m ² 1200W	£553.72

Suitable to go directly onto a prepared wooden floor. IPX7, 230V, cable thickness 4mm, 500mm width. Each installation requires a thermostat controller.

150W UNDERFLOOR HEATING MATS

Code	Description	Price
HHF1	1.0m ² 150W	£92.89
HHF15	1.5m ² 225W	£101.00
HHF2	2.0m ² 300W	£125.77
HHF25	2.5m ² 375W	£149.78
HHF3	3.0m ² 450W	£188.68
HHF35	3.5m ² 525W	£202.74
HHF4	4.0m ² 600W	£228.41
HHF5	5.0m ² 750W	£285.49
HHF6	6.0m ² 900W	£342.58
HHF7	7.0m ² 1050W	£399.68
HHF8	8.0m ² 1200W	£456.83
HHF9	9.0m ² 1350W	£506.41
HHF10	10m ² 1500W	£562.68
HHF12	12m ² 1800W	£639.88

Suitable to go directly onto a concrete subfloor or timber subfloor covered with insulation boards. IPX7, 230V, cable thickness 4mm, 500mm width. Each installation requires a thermostat controller.

HEATING MATS FEATURES AND BENEFITS

- Suitable for tiles, laminate and wood floors
- Energy efficient
- Produces around 80% less dust
- Self-adhesive
- Saves on space and no exposed pipes
- Quick and easy to install
- Suitable for small and large areas
- 12 year guarantee on mats

EACH UNDERFLOOR HEATING INSTALLATION REQUIRES A THERMOSTAT CONTROLLER

Turn to page 54 to choose yours



UNDERFLOOR HEATING CABLE & MEMBRANE

EACH UNDERFLOOR HEATING INSTALLATION REQUIRES A THERMOSTAT CONTROLLER

Turn to page 54 to choose yours



FEATURES AND BENEFITS

- Quick and easy to install and use
- Cost effective
- Space saver - When used as a primary heat source you don't need radiators, freeing up precious wall space
- Ideal for tiled floors. Also suitable for laminate and wood floors
- Designed to secure heating cable as well as act as a decoupling membrane
- Neutralises tensions between substrate and tiles, reducing cracking as the floor settles/moves
- Fully customisable
- Fit with flexible tile adhesive (not provided) and no levelling compound required

AS EASY AS 1,2,3

Combining underfloor heating and antifracture mat, this brilliant new product from Redroom could save you significant money and time in fitting. It really is as easy as 1,2,3.



STEP 1

Redroom decoupling membrane goes down on the floor.



STEP 2

Underfloor heating wire is spaced out within the guides on the membrane.



STEP 3

It's now ready for tiling. The membrane gives ultimate protection against tiles cracking that may occur due to settling and movement of the substrate underneath.



Time saving is a key benefit with this product, but what's more, the membrane offers a high level of protection against accidental damage plus it gives the installer a template for very accurate and consistent spacing. If you use underfloor heating, this is the product you need in your life.

DECOUPLING MEMBRANE ROLLS

Code	Description	Price
UFMEM1	5m ² Membrane Roll	£152.29
UFMEM2	15m ² Membrane Roll	£456.86

Polypropylene membrane with rounded square shaped studs that form channels specifically designed to embed and fasten electric heating cables. Suitable to go directly onto a concrete subfloor or timber covering insulating boards.

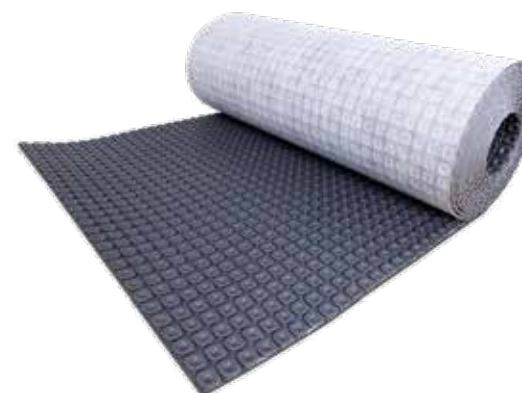

HEATING CABLE FOR MEMBRANE

Code	Description	Price
UFW1	10m Cable	£149.78
UFW2	20m Cable	£163.79
UFW3	28m Cable	£194.81
UFW4	41m Cable	£240.53
UFW5	50m Cable	£293.50
UFW6	57m Cable	£348.42
UFW7	70m Cable	£354.89
UFW8	81m Cable	£380.51
UFW9	90m Cable	£427.61
UFW10	100m Cable	£441.32
UFW11	129m Cable	£504.00
UFW12	142m Cable	£512.98
UFW13	165m Cable	£576.88

IPX7, 230V, cable thickness 4mm. Cold tail length 2.3m. 12 year guarantee. Each installation requires a thermostat controller.

Primary Heat = 150W/m² at 2 studs apart
Secondary Heat = 100W/m² at 3 studs apart

0.5m² area needs 10m linear cable.

THE THERMOSTAT CONTROLS



EACH UNDERFLOOR HEATING INSTALLATION REQUIRES A THERMOSTAT CONTROLLER



TOUCH THERMOSTAT CONTROL



- Large LED backlit display with air and floor sensor
- 7 day, 6 period programme
- Frost protection
- Screen lock

Code	Price
HFT1	£120.92

TOUCH+ THERMOSTAT CONTROL



- Sleek black design
- LED display with air and floor sensor
- 7 day, 6 period programme
- Frost protection
- Screen lock

Code	Price
HFT2	£173.48

WIFI ENABLED THERMOSTAT CONTROL

- Large LED backlit display with air and floor sensor
- 7 day, 6 period programme
- WiFi enabled
- Frost protection
- Screen lock
- Controlled via App

Code	Price
HFT3	£224.09



Technical Data	
Supply Voltage	220-240V ~
Power Output	100W/m ² @230V ~ / 150W/m ² @230V ~
Width	500mm
Construction	Round, twin conductor with 360° screen, one cold tail
Max Ambient Temp	65°C
Cable Thickness	4mm
Deformation Strength	600N
Pulling Strength	120N
Conductor Insulation	FEP
Outer Sheath	PVC
Screen	100% coverage, alu-foil, 0.5mm ² finned copper drain wire
Cold Lead	4m DTWB, 2x1.0mm ² earthed
Min Installation Temp	-5°C
Bending Radius	6 x Ø
IP Class	IPX7

Your Local Supplier



www.redroomheating.co.uk

Distributed by Barwick Bathroom Distribution LLP
We reserve the right to alter or amend product details without prior notice.
All dimensions are nominal. Errors and omissions excepted. All prices are inclusive of VAT at 20%