



**CELSI**   
*...the future of fire*



PREMIUM ELECTRIC FIRES COLLECTION 2023





## WELCOME TO CELSI

At Celsi we know how important it is to create a stylish and relaxing living environment. That's why we've developed this collection of premium electric fires.

I believe our success stems from a combination of innovative design, investment in technology and the highest quality manufacturing standards. To reflect my belief in their quality and durability, Celsi fires carry a minimum of 2 years guarantee, with some models extended by a further 3\* years limited warranty.

This brochure has been designed to make the purchase of your new Celsi heater as simple as possible.

I hope you find it both informative and inspiring.

### There is no more versatile fuel for home heating than electricity

With a range that includes beautifully crafted electric suites, feature wall smart fires, classically styled hearth inset fires, and contemporary stove designs, there is a Celsi fire to suit any home. Best of all you are free to enjoy any of these fantastic heating appliances in any room in your home simply by plugging into the nearest mains socket.

To learn more about the features and benefits of owning a Celsi electric fire please sit back and take a few moments to look through our Advanced Features section, along with our technology introduction to assist you in choosing your perfect Celsi fire experience.

## ADVANCED FEATURES



### THERMOSTATIC HEATING

Pre-set your heat comfort level for automatic temperature control via the handset.



### TIMER FUNCTION

Programmable 7-day heating timer with hourly on/off control. Up to 8 hrs sleep timer facility available on some models.



### LED EFFICIENCY

Flame picture, fuel bed brightness, mood lighting, our onboard LED's ensure effective energy saving low power consumption.



### ISOFLAME

Independent flame effect capable of displaying in isolation when no heat is required from the appliance.



### REAL WOOD

100% Real Wood Logs, natural, authentic, and unique. Accept no imitations!



### FLAME FUSION

A captivating fusion of soft and natural yellow flames with an attractive flare of blue flame intensity.



### COLOUR CYCLE

Fix your favourite or go dynamic as you cycle through an array of impressive colour changing options.



### COLOUR SMART

16 colour vibrant presets with 100+ options to customise the light ambience on flames, logs, and ember beds.



### MOOD LIGHTS

An ambient stream of colour-rich LED back lighting. Colours to compliment warm and cool interiors, or simply to suit your mood.



### CELSI SMART APP

Feature-rich and simple to operate. Control your Smart fire or stove from your phone or tablet with full handset functionality. Voice control Alexa and Google Assistant compatible.



Visit App Store or Google Play Store

Scan QR code to download app.



We are confident you are getting a product that is built to last. That's why we offer a 2 Year full Guarantee across our electric fires range, with an extended 3\* years limited warranty on selected Celsi models.



Compliance with Electrical Energy Rated Product (ERP) Integrated design features for optimal energy saving performance and assurance.



Conformity assessed and certified UK & EU



SUITES Real Wood U-VR Luminaire 800

BUILT-IN FIRES E-VR Commodus smart fires 1000/1250/1600

WALL FIRES U-VR Vader Aleesia

HEARTH FIRES U-VR Camber Satin Silver

STOVES E-H3D Hologram Genesis

Virtual Reality – True Flame Experience



Open and Glass fronted technology with 'Real Wood Logs', or natural log effects. Incredible illusions of 'Active Blazing Embers' and intense flame captivation. Styles include luxury Limestone Suites, beautiful wall and hearth inset models, all designed to look sensational and create comfortable controllable warmth.

Feature Pages 8-9

**Firebeam Suites**

U-VR Firebeam 800/600/800XL/600XL	10-17
-----------------------------------	-------

**Freestanding Suites**

U-VR Luminaire 800/600	18-19
U-VR Skyfall 800/600	20-23

U-VR Orbital 800	24
U-VR Vega	25
U-VR Gemma 800/600	26-28
U-VR Adour Aleesia/Adour Elite/Adour Asencio/Adour	29-33
U-VR Canelo	34
U-VR Elara	35

**Limestone Inset Suites**

U-VR Parada Elite	36
U-VR Avignon Elite	37
U-VR Aleesia	38
U-VR Asencio	39
U-VR Angelo	40
U-VR Boticelli	41
U-VR Pablo	42

**Wall Inset Fires**

U-VR Elite	43
U-VR Vichy	44
U-VR Metz	45
U-VR Instinct	46
U-VR Evora Asencio & Asencio	47
U-VR Vader Aleesia & Aleesia	48-49
U-VR Celena	50
U-VR Impulse	51

**Hearth Inset Fires**

U-VR Arcadia	52
U-VR Decadence	53
U-VR Camber	54
U-VR Frontier	55
U-VR Essence	56
U-VR Designer	57
U-VR Endura	58
U-VR Contemporary	59

Virtual Reality – Smart & Advanced Flame Projection



Advanced Flame Projection, and Holographic 3D Technologies simulate totally natural log fire effects. Smart connectivity, colours, and configuration raise the appearance and functionality of these electric fires and stoves to new levels.

SMART Features Pages 6-7. 3D Hologram Stove 90-91

**Freestanding Suites - 3 Sided Glass**

<b>CELSI SMART</b> E-VR Quantum s1250/s1000	60-61
E-VR Media 1100/750	62-63
E-VR Carino 1100/750	64-65
E-VR Gemma 1000	66-67
E-VR Orbital 1000	68-69

**Built-In Fires - 3 Sided Glass**

<b>CELSI SMART</b> E-VR Commodus s1600	70-71
E-VR Commodus s1250	72-73
E-VR Commodus s1000	74-75

E-VR 1400	76-77
E-VR 1100	78-79
E-VR 750	80

**Wall Mounted Suites - 3 Sided Glass**

E-VR Volare 750/1100	81-83
----------------------	-------

**Wall Inset Fires**

E-VR Commodus	84
E-VR Vichy	85

**Wall Mounted Fires**

E-VR Louvre	86
E-VR Bisilica	87

**Hearth Inset Fires**

E-VR Acero	88-89
E-VR Parrilla	90
E-VR Contemporary	91

**Stoves**

<b>CELSI SMART</b> H3D Hologram Genesis	92-93
E-VR Spectre	94-95
E-VR Stratford	96-97
E-VR Rochester	98-99
E-VR Arundel	100
E-VR Luxima	101

Xtra Dimensional – High Definition Fire



Glass Fronted, extra deep fuel effect with high definition 3D flames. The E-XD range features impressive 'hang-on-the-wall' fires framed with Marble, Limestone, Premier board, and Glass fascia's.

Our hearth inset fires and stoves provide a wide selection of designs that complement both modern and traditional home interiors.

**Wall Mounted Fires**

E-XD Prestige	102-103
E-XD Black Glass	104
E-XD Royal Botticino	105
E-XD Travertine	106
E-XD Piano Black	107

**Hearth Inset Fires**

E-XD Camber	108
E-XD Decadence	109
E-XD Essence	110
E-XD Arcadia	111
E-XD Signature	112
E-XD Bauhaus	113
E-XD Daisy	114
E-XD Caress	115

**Stoves**

Electr stove XD Metal 1 & 2	116-117
Electr stove XD Glass 1 & 2	118-119

Inspired Flame Effect Technologies



Through illusion and LED light technology beautiful flames emerge to provide a range of distinctive electric fire effects that bewilder and excite.

**Wall Mounted Fires**

Flamonik Rapture	120
Flamonik Enchant	121

**Hearth Inset Firesw**

Accent Traditional	122
Accent Infusion	123

**DIMENSIONS**

124-133



# CELSI

SMART FIRES

## CELSI SMART Electriflame Virtual Reality fires.

Next generation Flame Projection technology creates the flame illusion to the front, the centre, and the rear of the fuel bed. This simulates a totally natural log fire effect that raise the appearance and functionality of electric fires to a new level.

### CONFIGURATION

This range of **built-in 3-sided glass models** offer the perfect solution for your feature wall. Available in three sizes 1000, 1250, and 1600.

E-VR Commodus Smart fires are supplied with side blanking panels giving you the option to customise your installation by converting from a 3-sided fire, to a 2-sided left or right configuration, or to simply install as a single glass fronted wall inset fire.

### COLOUR

Enjoy 16 pre-set ambient colour modes, and over 100+ multi colour combinations to customise the light ambience on flames, logs, and ember beds. To simplify your choice why not relax with a slow cycle through the colour spectrum in our **fully immersive Animation mode**.

### CONNECTIVITY

Get connected with our feature-rich and simple to operate **smart app**. Available to download on the App Store, or get in on Google Play!

### CONTROL

Control your fire from your smart phone or tablet with **full handset functionality**. Further applied smart technology allows you to voice control your fire using Amazon Alexa and Google Assistant.



Scan the QR code to download our app



Virtual Reality – Smart Flame Projection

## BUILT-IN FIRES PAGES 70-75



Controllable LED lights positioned above, beneath, and behind the fuelbed creates an illusion of hot embers, burning logs, and tall ascending flames that deliver a real fire experience. These lights operate with 16 preset colour selections, advanced automatic hue cycle, or custom interactive personal choice from 100+ colour preference on flames, logs, and underbed embers.



E-VR Commodus s1250. 2-sided glass, right side configuration.



E-VR Commodus s1600. 3-sided glass configuration.

# REAL WOOD LOGS

## NATURAL FIRE RANGE

CELSI have taken Ultiflame Virtual Reality fires to the next level. Our most successful natural flame effect is now further complemented with a maximum depth exciting arrangement of real wood logs fixed into a lively 'Active crystal ember fuel bed'

The fire realism is sensational, and the natural wood log arrangement is visually stunning.

This next generation electric fire effect is available in a range of contemporary Firebeams and Suites, each including integrated dimmable LED lighting.



### REAL WOOD

100% Real Wood Logs, natural, authentic, and unique. Accept no imitations!

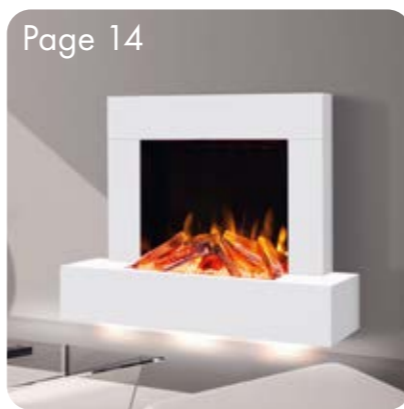

U-VR Firebeam XL 600 Suite



U-VR Firebeam 800 Suite



U-VR Luminaire 600 Suite



U-VR Skyfall 800 Suite



Active Blazing Embers

Our Firebeam models include wall mounted beams smartly framed by sleek glass with chrome fittings that totally complement this product.

For a larger feature wall suite see our 'Firebeam XL' models, these provide a luxury feature fireplace that requires less wall depth for easy installation.

For a completely fuss-free installation our freestanding suites only require the need to place down and plug in.

CELSI Ultiflame VR fires are premium products with integrated design features for optimal energy saving performance and assurance.



Virtual Reality – True Flame Experience

# FIREBEAM 800

Ultriflame VR Inset Illumia Suite

## Features

- Open fire experience
- Extra deep fuel bed
- Natural real wood logs
- Active crystal embers
- Single or dual colour flame
- LED brightness control
- Thermostatic remote & manual control operation
- Dimmable LED beam lighting



Smooth White



Real Wood Logs



Smooth Mist

## Specification

Suite Dimensions: mm	H 540 x W 1200 x D 170
Heat Output	1.0kW - 2.0kW
Suite Finish	<input type="checkbox"/> Smooth White
Painted	<input type="checkbox"/> Smooth Mist



Ecodesign  
Compliant



Video

# FIREBEAM 600

Ultiflame VR Inset Illumia Suite

## Features

- Open fire experience
- Extra deep fuel bed
- Natural real wood logs
- Active crystal embers
- Single or dual colour flame
- LED brightness control
- Thermostatic remote & manual control operation
- Dimmable LED beam lighting



Smooth Mist



Real Wood Logs



Smooth White

## Specification

Suite Dimensions: mm	H 615 x W 870 x D 170
Heat Output	1.0kW - 2.0kW
Suite Finish	<input type="checkbox"/> Smooth White
Painted	<input type="checkbox"/> Smooth Mist



Video

**VR FIREBEAM XL800**

Ultriflame VR Semi-Inset Illumia Suite

**Features**

- Open fire experience
- Extra deep fuel bed
- Natural real wood logs
- Active crystal embers
- Single or dual colour flame
- LED brightness control
- Thermostatic remote & manual control operation
- Dimmable LED beam lighting



Real Wood Logs



**Specification**

Suite Dimensions: mm	H 697 x W 1302 x D 213
Heat Output	1.0kW - 2.0kW
Suite Finish Painted	<input type="checkbox"/> Smooth White



Video



# WR FIREBEAM XL600

Ultriflame VR Semi-Inset Illumia Suite

## Features

- Open fire experience
- Extra deep fuel bed
- Natural real wood logs
- Active crystal embers
- Single or dual colour flame
- LED brightness control
- Thermostatic remote & manual control operation
- Dimmable LED beam lighting



Real Wood Logs



## Specification

Suite Dimensions: mm	H 794 x W 970 x D 213
Heat Output	1.0kW - 2.0kW
Suite Finish	<input type="checkbox"/> Smooth White
Painted	



Video

# LUMINAIRE 800

Ultriflame VR Freestanding Illumia Suite



Video



## Features

- Open fire experience
- Extra deep fuel bed
- Natural real wood logs
- Active crystal embers
- Single or dual colour flame
- LED brightness control
- Thermostatic remote & manual control operation
- Dimmable LED suite lighting

Real Wood Logs



## Specification

Suite Dimensions: mm	H 1005 x W 1478 x D 400
Heat Output	1.0kW - 2.0kW
Suite Finish Painted	<input type="checkbox"/> Smooth White

# LUMINAIRE 600

Ultriflame VR Freestanding Illumia Suite



Video



## Features

- Open fire experience
- Extra deep fuel bed
- Natural real wood logs
- Active crystal embers
- Single or dual colour flame
- LED brightness control
- Thermostatic remote & manual control operation
- Dimmable LED suite lighting

Real Wood Logs



## Specification

Suite Dimensions: mm	H 1108x W 1350 x D 400
Heat Output	1.0kW - 2.0kW
Suite Finish Painted	<input type="checkbox"/> Smooth White

# WR SKYFALL 800

Ultiflame VR Freestanding Illumia Suite

## Features

- Open fire experience
- Extra deep fuel bed
- Natural real wood logs
- Active crystal embers
- Single or dual colour flame
- LED brightness control
- Thermostatic remote & manual control operation
- Dimmable LED suite lighting



Smooth White



Real Wood Logs



Smooth White & Mist

## Specification

Suite Dimensions: mm	H 775 x W 1480 x D 375
Heat Output	1.0kW - 2.0kW
Suite Finish	<input type="checkbox"/> Smooth White
Painted	<input type="checkbox"/> Smooth White & Mist



Video

# SKYFALL 600

Ultime VR Freestanding Illumia Suite

## Features

- Open fire experience
- Extra deep fuel bed
- Natural real wood logs
- Active crystal embers
- Single or dual colour flame
- LED brightness control
- Thermostatic remote & manual control operation
- Dimmable LED suite lighting



Smooth White & Mist



Real Wood Logs



Smooth White & Mist

## Specification

Suite Dimensions: mm	H 877 x W 1113 x D 375
Heat Output	1.0kW - 2.0kW
Suite Finish	<input type="checkbox"/> Smooth White
Painted	<input type="checkbox"/> Smooth White & Mist



Video

# VR ORBITAL 800

Ultiflame VR Freestanding Illumia Suite



Video



Smooth Mist

### Features

- Open fire experience
- Dimmable LED surround lighting
- Customisable fuel effect
- Silver birch ceramic logs
- Crystal ash embers
- Single or dual colour flame
- LED brightness control
- Thermostatic remote & manual control operation



Smooth Cream



Smooth White

### Suite Finishes

- Painted
- Smooth White
  - Smooth Mist
  - Smooth Cream

### Specification

Suite Dimensions: mm	H 850 x W 1466 x D 360
Heat Output	0.8kW - 1.6kW

# VEGA

Ultiflame VR Freestanding Illumia Suite



Video



### Features

- Open fire experience
- Customisable fuel effect
- Silver birch ceramic logs
- Crystal ash embers
- Single or dual colour flame
- LED brightness control
- Thermostatic remote & manual control operation



### Specification

Suite Dimensions: mm	H 892 x W 1430 x D 330
Heat Output	0.8kW - 1.6kW

### Suite Finishes

- Painted Surround  
Black interior
- Smooth White

# WR GEMMA 800

## Ultriflame VR Freestanding Illumia Suite

### Features

- Open fire experience
- Dimmable LED surround lighting
- Customisable fuel effect
- Silver birch ceramic logs
- Crystal ash embers
- Single or dual colour flame
- LED brightness control
- Thermostatic remote & manual control operation



Smooth White



Textured Black & White



Textured White

### Specification

Suite Dimensions: mm	H 740 x W 1465 x D 360
Heat Output	0.8kW - 1.6kW
Suite Finish Painted	<input type="checkbox"/> Smooth White <input checked="" type="checkbox"/> Textured White <input type="checkbox"/> Textured Black



Video

# VR GEMMA 600

Ultilflame VR Freestanding Illumia Suite



Video



Textured White

### Features

- Open Fronted Fire
- Dimmable LED surround lighting
- Customisable fuel effect
- Silver birch ceramic logs
- Crystal ash embers
- Single or dual colour flame
- LED brightness control
- Thermostatic remote & manual control operation



Smooth White



Textured Black & White

### Suite Finishes

Painted

- Smooth White
- Textured White
- Textured Black



### Specification

Suite Dimensions: mm	H 835 W 1185 D 360
Heat Output	0.8kW - 1.6kW

# VR ADOUR ALEESIA

Ultilflame VR Freestanding Illumia Suite



Video



### Features

- Glass Fronted Fire
- Dimmable LED surround lighting
- Customisable fuel effect
- Silver birch ceramic logs
- Crystal ash embers
- Single or dual colour flame
- LED brightness control
- Thermostatic remote & manual control operation

Flame Fusion – dual colour



### Specification

Suite Dimensions: mm	H 990 x W 1465 x D 380
Heat Output	0.8kW - 1.6kW

### Suite Finishes

Painted

- Smooth White

Smooth White



## ADOUR ELITE

Ultriflame VR Freestanding Illumia Suite

### Features

- Open fire experience
- Dimmable LED surround lighting
- Customisable fuel effect
- Silver birch ceramic logs
- Crystal ash embers
- Single or dual colour flame
- LED brightness control
- Thermostatic remote & manual control operation



Smooth Mist



Smooth Cream



Video

### Specification

Suite Dimensions: mm	H 990 x W 1465 x D 380
Heat Output	0.8kW - 1.6kW
Suite Finishes Painted	<input type="checkbox"/> Smooth White <input type="checkbox"/> Smooth Mist <input type="checkbox"/> Smooth Cream



# ADOUR ASENCIO

Ultriflame VR Freestanding Illumia Suite



Video



Smooth White

## Features

- Glass Fronted Fire
- Dimmable LED surround lighting
- Customisable fuel effect
- Silver birch ceramic logs
- Crystal ash embers
- Single or dual colour flame
- LED brightness control
- Thermostatic remote & manual control operation

Flame Fusion – dual colour



## Specification

Suite Dimensions: mm	H 1090 x W 1340 x D 380
Heat Output	0.8kW – 1.6kW

## Suite Finishes

Painted surround  
Black interior and hearth

Smooth White

# ADOUR

Ultriflame VR Freestanding Illumia Suite



Video



Smooth White

## Features

- Open fire experience
- Dimmable LED surround lighting
- Customisable fuel effect
- Silver birch ceramic logs
- Crystal ash embers
- Single or dual colour flame
- LED brightness control
- Thermostatic remote & manual control operation



Smooth Cream

Smooth Mist



## Specification

Suite Dimensions: mm	H 1090 x W 1340 x D 380
Heat Output	0.8kW – 1.6kW

## Suite Finishes

Painted surround  
Black interior and hearth

Smooth White  
 Smooth Mist  
 Smooth Cream



Video



**Features**

- Open fire experience
- Dimmable LED surround lighting
- Customisable fuel effect
- Silver birch ceramic logs
- Crystal ash embers
- Single or dual colour flame
- LED brightness control
- Thermostatic remote & manual control operation



**Specification**

Suite Dimensions: mm	H 1090 W 1340 D 340
Heat Output	0.8kW - 1.6kW

**Suite Finishes**

Painted Surround Black interior	<input type="checkbox"/> Smooth White
------------------------------------	---------------------------------------



Video



**Features**

- Open fire experience
- Customisable fuel effect
- Silver birch ceramic logs
- Crystal ash embers
- Single or dual colour flame
- LED brightness control
- Thermostatic remote & manual control operation



**Specification**

Suite Dimensions: mm	H 892 x W 1228 x D 330
Heat Output	0.8kW - 1.6kW



Smooth Cream



Smooth White

**Suite Finishes**

Painted Surround Black interior	<input type="checkbox"/> Smooth White
	<input type="checkbox"/> Smooth Mist
	<input type="checkbox"/> Smooth Cream

# PARADA ELITE

Ultiflame VR Inset Limestone Illumia Suite



Video



## Features

- Open fire experience
- Dimmable LED surround lighting
- Customisable fuel effect
- Silver birch ceramic logs
- Crystal ash embers
- Single or dual colour flame
- LED brightness control
- Thermostatic remote & manual control operation
- Available in two sizes



## Specification

Suite Dimensions: mm	54" 58"	H 990 x W 1350 x D 400 H 990 x W 1464 x D 400
Heat Output	0.8kW – 1.6kW	

## Suite Finish

Natural  Limestone

# AVIGNON ELITE

Ultiflame VR Inset Limestone Suite



Video



## Features

- Open fire experience
- Customisable fuel effect
- Silver birch ceramic logs
- Crystal ash embers
- Single or dual colour flame
- LED brightness control
- Thermostatic remote & manual control operation
- Available in two sizes



## Specification

Suite Dimensions: mm	54" 58"	H 990 x W 1350 x D 380 H 990 x W 1464 x D 380
Heat Output	0.8kW – 1.6kW	

## Suite Finish

Natural  Limestone



Video



**Features**

- Glass Fronted Fire
- Dimmable LED surround lighting
- Customisable fuel effect
- Silver birch ceramic logs
- Crystal ash embers
- Single or dual colour flame
- LED brightness control
- Thermostatic remote & manual control operation
- Available in two sizes



**Specification**

Suite Dimensions: mm	54" 58"	H 1050 x W 1370 x D 400 H 1050 x W 1470 x D 400
Heat Output	0.8kW - 1.6kW	

**Suite Finish**

Natural  Limestone



Video



**Features**

- Glass Fronted Fire
- Customisable fuel effect
- Silver birch ceramic logs
- Crystal ash embers
- Single or dual colour flame
- LED brightness control
- Thermostatic remote & manual control operation



**Specification**

Suite Dimensions: mm	H 1095 x W 1376 x D 380
Heat Output	0.8kW - 1.6kW

**Suite Finish**

Natural  Limestone



Video



**Features**

- Open fire experience
- Customisable fuel effect
- Silver birch ceramic logs
- Crystal ash embers
- Single or dual colour flame
- LED brightness control
- Thermostatic remote & manual control operation



**Specification**

Suite Dimensions: mm	H 995 x W 1300 x D 380
Heat Output	0.8kW - 1.6kW

**Suite Finish**

Natural  Limestone



Video



**Features**

- Open fire experience
- Customisable fuel effect
- Silver birch ceramic logs
- Crystal ash embers
- Single or dual colour flame
- LED brightness control
- Thermostatic remote & manual control operation



**Specification**

Suite Dimensions: mm	H 980 x W 1280 x D 380
Heat Output	0.8kW - 1.6kW

**Suite Finish**

Natural  Limestone





Ultiflame VR Inset Limestone Suite



Video



**Features**

- Open fire experience
- Customisable fuel effect
- Silver birch ceramic logs
- Crystal ash embers
- Single or dual colour flame
- LED brightness control
- Thermostatic remote & manual control operation



**Specification**

Suite Dimensions: mm	H 980 x W 1220 x D 410
Heat Output	0.8kW - 1.6kW

**Suite Finish**

Natural  Limestone



Ultiflame VR Wall Inset Fire



Video



**Features**

- Open fire experience
- Customisable fuel effect
- Silver birch ceramic logs
- Crystal ash embers
- Single or dual colour flame
- LED brightness control
- Thermostatic remote & manual control operation



**Specification**

Fire Dimensions: mm	H 352 x W 843 x D 182
Heat Output	0.8kW - 1.6kW



Ultiflame VR Wall Inset Fire



Video

Satin Silver



**Features**

- Open fire experience
- Customisable fuel effect
- Silver birch ceramic logs
- Crystal ash embers
- Single or dual colour flame
- LED brightness control
- Thermostatic remote & manual control operation



Black Textured



Satin Champagne

**Finishes**

- Steel Fabricated Fascia
  - Satin Silver
  - Satin Champagne
  - Black Textured
- Brushed Metallic or Black Textured Paint

**Specification**

Dimensions: mm	H 540 x W 1490 x D 71
Heat Output	0.8kW - 1.6kW



Ultiflame VR Wall Inset Fire



Video

Satin Champagne



**Features**

- Open fire experience
- Customisable fuel effect
- Silver birch ceramic logs
- Crystal ash embers
- Single or dual colour flame
- LED brightness control
- Thermostatic remote & manual control operation



Satin Silver

**Finishes**

- Steel Fabricated Fascia
  - Satin Silver
  - Satin Champagne
- Brushed Metallic

**Specification**

Dimensions: mm	H 540 x W 1490 x D 22.5
Heat Output	0.8kW - 1.6kW

# INSTINCT

Ultiflame VR Wall Inset Fire



Video



Satin Champagne

## Features

- Open fire experience
- Customisable fuel effect
- Silver birch ceramic logs
- Crystal ash embers
- Single or dual colour flame
- LED brightness control
- Thermostatic remote & manual control operation



Satin Black



## Specification

Dimensions: mm	H 647 x W 1138 x D 60
Heat Output	0.8kW - 1.6kW

## Finishes

Steel Fabricated Fascia	Satin Champagne
Steel Fabricated Fascia Brushed Metallic	Satin Black

# EVORA ASENCIO & ASENCIO

Ultiflame VR Wall Inset Fire



Video



Evora Asencio

## Features

- Glass fronted fire
- Customisable fuel effect
- Silver birch ceramic logs
- Crystal ash embers
- Single or dual colour flame
- LED brightness control
- Thermostatic remote & manual control operation



Asencio trimless installation



## Specification

Dimensions: mm	Evora Asencio H 768 x W 762 x D 19
	Asencio H 570x W 570 x D 183
Heat Output	0.8kW - 1.6kW

## Finish

Steel Fabricated Fascia Dual Metallic	Black Nickel & Chrome
--	-----------------------



Vader Aleesia Black Nickel & Black



## VADER ALEESIA & ALEESIA

Ultiflame VR Wall Inset Fire

### Features

- Glass fronted fire
- Customisable fuel effect
- Silver birch ceramic logs
- Crystal ash embers
- Single or dual colour flame
- LED brightness control
- Thermostatic remote & manual control operation



THERMO-  
STATIC



7 DAY  
TIMER



ENERGY  
SAVING



ISO  
FLAME



FLAME  
FUSION



Vader Aleesia Black Nickel & Chrome



Aleesia trimless installation



Video

### Specification

Dimensions: mm	Vader Aleesia H 683 x W 963 x D 21 Aleesia H 490 x W 770 x D 183
Heat Output	0.8kW - 1.6kW
Finishes	<div style="display: flex; gap: 10px;"> <div style="width: 15px; height: 15px; background-color: black; border: 1px solid black;"></div> Black Nickel &amp; Black                 </div> <div style="display: flex; gap: 10px;"> <div style="width: 15px; height: 15px; background-color: black; border: 1px solid black;"></div> Black Nickel &amp; Chrome                 </div>
Steel Fabricated Fascia	
Dual Metallic	



Video



**Features**

- Open fire experience
- Customisable fuel effect
- Silver birch ceramic logs
- Crystal ash embers
- Single or dual colour flame
- LED brightness control
- Thermostatic remote & manual control operation



**Specification**

Fire Dimensions: mm	H 447 x W 560 x D 182
Heat Output	0.8kW - 1.6kW



Video



Satin Silver

**Features**

- Open fire experience
- Customisable fuel effect
- Silver birch ceramic logs
- Crystal ash embers
- Single or dual colour flame
- LED brightness control
- Thermostatic remote & manual control operation



**Specification**

Dimensions: mm	H 742 x W 860 x D 60
Heat Output	0.8kW - 1.6kW



Satin Black

**Finishes**

Steel Fabricated Fascia	Satin Silver
Brushed Metallic	Satin Black



Video



Black & Gold

**Features**

- Open fire experience
- Customisable fuel effect
- Silver birch ceramic logs
- Crystal ash embers
- Single or dual colour flame
- LED brightness control
- Thermostatic remote & manual control operation



**Optional Extras**

75mm Spacer frame  
For flat wall installation



Black & Chrome

**Finishes**

High Quality Cast Iron Fascia  
Paint and Metallic Plated



**Specification**

Dimensions: mm	H 612 x W 528 x D 154
Heat Output	0.75kW - 1.5kW



Video



Chrome

**Features**

- Open fire experience
- Customisable fuel effect
- Silver birch ceramic logs
- Crystal ash embers
- Single or dual colour flame
- LED brightness control
- Thermostatic remote & manual control operation



**Optional Extras**

75mm Spacer frame  
For flat wall installation



Gold



Black Nickel

**Specification**

Dimensions: mm	H 630 x W 528.5 x D 151
Heat Output	0.75kW - 1.5kW

**Finishes**

High Quality Cast Iron Fascia  
Metallic Plated

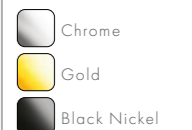



Video



Satin Silver

**Features**

- Open fire experience
- Customisable fuel effect
- Silver birch ceramic logs
- Crystal ash embers
- Single or dual colour flame
- LED brightness control
- Thermostatic remote & manual control operation



**Optional Extras**

75mm Spacer frame  
For flat wall installation



Satin Champagne

Black Textured

**Finishes**

Anodised Aluminium Fascia  
Brushed Metallic or  
Black Textured Paint

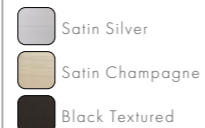

**Specification**

Dimensions: mm	H 619 x W 537 x D 135
Heat Output	0.75kW - 1.5kW



Video



**Features**

- Open fire experience
- Customisable fuel effect
- Silver birch ceramic logs
- Crystal ash embers
- Single or dual colour flame
- LED brightness control
- Thermostatic remote & manual control operation



**Optional Extras**

75mm Spacer frame  
For flat wall installation

**Specification**

Dimensions: mm	H 617 x W 541 x D 131
Heat Output	0.75kW - 1.5kW

**Finish**

Steel Fabricated Fascia  
Dual Finish  
Paint & Metallic

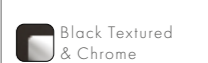



Video



Black

**Features**

- Open fire experience
- Customisable fuel effect
- Silver birch ceramic logs
- Crystal ash embers
- Single or dual colour flame
- LED brightness control
- Thermostatic remote & manual control operation



**Optional Extras**

75mm Spacer frame  
For flat wall installation



Satin Silver

**Specification**

Dimensions: mm	H 619 x W 537 x D 127
Heat Output	0.75kW - 1.5kW

**Finishes**

- Steel Fabricated Fascia
- Brushed Metallic
- Smooth Black Paint

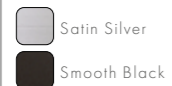

Video



Black Nickel & Chrome

**Features**

- Open fire experience
- Customisable fuel effect
- Silver birch ceramic logs
- Crystal ash embers
- Single or dual colour flame
- LED brightness control
- Thermostatic remote & manual control operation



**Optional Extras**

75mm Spacer frame  
For flat wall installation



Chrome & Black

**Specification**

Dimensions: mm	H 599 x W 498 x D 129
Heat Output	0.75kW - 1.5kW

**Finishes**

- Steel Fabricated Fascia
- Dual Metallic





Video



Chrome

**Features**

- Open fire experience
- Customisable fuel effect
- Silver birch ceramic logs
- Crystal ash embers
- Single or dual colour flame
- LED brightness control
- Thermostatic remote & manual control operation



**Optional Extras**

75mm Spacer frame  
For flat wall installation



Black

**Finishes**

Steel Fabricated Fascia  
Metallic or Smooth Black Paint

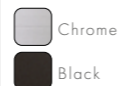

**Specification**

Dimensions: mm	H 598 x W 497 x D 126
Heat Output	0.75kW - 1.5kW



Video



Satin Silver

**Features**

- Open fire experience
- Customisable fuel effect
- Silver birch ceramic logs
- Crystal ash embers
- Single or dual colour flame
- LED brightness control
- Thermostatic remote & manual control operation



**Optional Extras**

75mm Spacer frame  
For flat wall installation



Satin Champagne

**Finishes**

Steel Fabricated Fascia  
Brushed Metallic



**Specification**

Dimensions: mm	H 598 x W 493 x D 132
Heat Output	0.75kW - 1.5kW



E-VR Quantum s1250

## ER QUANTUM s1250/s1000

Electriflame VR Freestanding Smart Illumia Suites

### Features

- Flame Projection Technology
- 3 sided glass smart fire
- Dimmable LED surround lighting
- Customisable fuel effect
- Silver birch ceramic logs
- Crystal ash embers
- 16 pre-set colours/100+ custom/Animation mode
- LED brightness control
- Thermostatic remote & manual control operation
- Amazon Alexa and Google Assistant compatible



**CELSI SMART APP**  
 Feature-rich and simple to operate. Control your fire from your smart phone or tablet with full handset functionality.



E-VR Quantum s1000



Video

### Specification

Suite Dimensions: mm	s1250: H 785 x W 1565 x D360 s1000: H 785 x W 1390 x D360
Heat Output	1.0kW - 2.0kW
Suite Finishes Painted	<input type="checkbox"/> Smooth White



Celsi Smart Fires have 16 pre-set ambient colour modes, and over 100+ multi colour combinations to customise the light ambience on flames, logs, and ember beds. To simplify your choice you can relax with a slow cycle through the colour spectrum in our fully immersive Animation mode.



Video

# ER MEDIA 1100

Electrifiame VR Freestanding Illumia Suite



Video



## Features

- Flame Projection Technology
- 3 sided glass fire
- Dimmable LED surround lighting
- Media storage
- Customisable fuel effect
- Silver birch ceramic logs
- Crystal ash embers
- Single or dual colour flame
- LED brightness control
- Thermostatic remote & manual control operation

Flame Projection Technology



## Specification

Suite Dimensions: mm	H 1126 x W 1595 x D 408
Heat Output	1.0kW - 2.0kW
Suite Finish Painted	<input type="checkbox"/> Smooth White

# ER MEDIA 750

Electrifiame VR Freestanding Illumia Suite



Video



## Features

- Flame Projection Technology
- 3 sided glass fire
- Dimmable LED surround lighting
- Media storage
- Customisable fuel effect
- Silver birch ceramic logs
- Crystal ash embers
- Single or dual colour flame
- LED brightness control
- Thermostatic remote & manual control operation

## Optional Extras

Woodland logs fuel effect



## Specification

Suite Dimensions: mm	H 1126 x W 1400 x D 408
Heat Output	1.0kW - 2.0kW
Suite Finish Painted	<input type="checkbox"/> Smooth White



# ER CARINO 1100

Electriflame VR Freestanding Illumia Suite



Video



## Features

- Flame Projection Technology
- 3 sided glass fire
- Dimmable LED surround lighting
- Customisable fuel effect
- Silver birch ceramic logs
- Crystal ash embers
- Single or dual colour flame
- LED brightness control
- Thermostatic remote & manual control operation

Flame Projection Technology



## Specification

Suite Dimensions: mm	H 840 x W 1467 x D 370
Heat Output	1.0kW - 2.0kW
Suite Finish	<input type="checkbox"/> Smooth White
Painted	

# ER CARINO 750

Electriflame VR Freestanding Illumia Suite



Video



## Features

- Flame Projection Technology
- 3 sided glass fire
- Dimmable LED surround lighting
- Customisable fuel effect
- Silver birch ceramic logs
- Crystal ash embers
- Single or dual colour flame
- LED brightness control
- Thermostatic remote & manual control operation

## Optional Extras

Woodland logs fuel effect



## Specification

Suite Dimensions: mm	H 840 x W 1118 x D 370
Heat Output	1.0kW - 2.0kW
Suite Finish	<input type="checkbox"/> Smooth White
Painted	

# ER GEMMA 1000

Electrifiame VR Freestanding Illumia Suite

## Features

- Flame Projection Technology
- Glass fronted fire
- Dimmable LED surround lighting
- Customisable fuel effect
- Silver birch ceramic logs
- Crystal ash embers
- Single or dual colour flame
- LED brightness control
- Thermostatic remote & manual control operation



Smooth White



Textured Black & White



Textured White

## Specification

Suite Dimensions: mm	H 724 x W 1565 x D 360
Heat Output	0.8kW - 1.6kW
Suite Finishes Painted	<input type="checkbox"/> Smooth White <input type="checkbox"/> Textured White <input type="checkbox"/> Textured Black



Video

# ER ORBITAL 1000

Electrifiame VR Freestanding Illumia Suite

## Features

- Flame Projection Technology
- Glass fronted fire
- Dimmable LED surround lighting
- Customisable fuel effect
- Silver birch ceramic logs
- Crystal ash embers
- Single or dual colour flame
- LED brightness control
- Thermostatic remote & manual control operation



Smooth Mist



Smooth White

## Specification

Suite Dimensions: mm	H 855 x W 1600 x D 360
Heat Output	0.8kW - 1.6kW
Suite Finishes Painted	<input type="checkbox"/> Smooth White <input type="checkbox"/> Smooth Mist



Video



Shown as 3-sided glass installation



Video

**Specification**

Fire Dimensions: mm	H 330 x W 1600 x D 219
Heat Output	0.6kW – 1.8kW

**ER** **COMMODUS s1600**

Electriflame VR Built-In 3 Sided Glass Smart Fire

**Features**

- Flame Projection Technology
- 3 sided glass smart fire
- Customisable fuel effect
- Silver birch ceramic logs
- Crystal ash embers
- 16 pre-set colours/100+ custom/Animation mode
- LED brightness control
- Thermostatic remote & manual control operation
- Amazon Alexa and Google Assistant compatible
- Side blanking for 2 & 1 sided installations



**CELSI SMART APP**  
 Feature-rich and simple to operate. Control your fire from your smart phone or tablet with full handset functionality.



Celsi Smart Fires have 16 pre-set ambient colour modes, and over 100+ multi colour combinations to customise the light ambience on flames, logs, and ember beds. To simplify your choice you can relax with a slow cycle through the colour spectrum in our fully immersive Animation mode.



 Scan the QR code to download our app



2-sided glass Installation

## ER COMMODUS s1250

Electriflame VR Built-In 3 Sided Glass Smart Fire

### Features

- Flame Projection Technology
- 3 sided glass smart fire
- Customisable fuel effect
- Silver birch ceramic logs
- Crystal ash embers
- 16 pre-set colours/100+ custom/Animation mode
- LED brightness control
- Thermostatic remote & manual control operation
- Amazon Alexa and Google Assistant compatible
- Side blanking for 2 & 1 sided installations



**CELSI SMART APP**  
Feature-rich and simple to operate. Control your fire from your smart phone or tablet with full handset functionality.



Celsi Smart Fires have 16 pre-set ambient colour modes, and over 100+ multi colour combinations to customise the light ambience on flames, logs, and ember beds. To simplify your choice you can relax with a slow cycle through the colour spectrum in our fully immersive Animation mode.



Scan the QR code to download our app



Video

### Specification

Fire Dimensions: mm	H 330 x W 1250 x D 219
Heat Output	0.8kW - 1.6kW

# ER COMMODUS s1000

Electriflame VR Built-In 3 Sided Glass Smart Fire

## Features

- Flame Projection Technology
- 3 sided glass smart fire
- Customisable fuel effect
- Silver birch ceramic logs
- Crystal ash embers
- 16 pre-set colours/100+ custom/Animation mode
- LED brightness control
- Thermostatic remote & manual control operation
- Amazon Alexa and Google Assistant compatible
- Side blanking for 2 & 1 sided installations
- Fascia option available



**CELSI SMART APP**  
Feature-rich and simple to operate. Control your fire from your smart phone or tablet with full handset functionality.



Celsi Smart Fires have 16 pre-set ambient colour modes, and over 100+ multi colour combinations to customise the light ambience on flames, logs, and ember beds. To simplify your choice you can relax with a slow cycle through the colour spectrum in our fully immersive Animation mode.



Scan the QR code to download our app



3-sided glass Installation

Black Nickel & Black



Video

## Specification

Fire Dimensions: mm	H 330 x W 1000 x D 219
Fascia Dimensions: mm	H 540 x W 1200 x D 19
Heat Output	0.8kW – 1.6kW
Finishes	 Black Nickel & Black



Video



**ER 1400**

Electrifiame VR Built-In 3 Sided Glass Fire

**Features**

- Flame Projection Technology
- 3 sided glass fire
- Customisable fuel effect
- Silver birch ceramic logs
- Crystal ash embers
- Single or dual colour flame
- LED brightness control
- Thermostatic remote & manual control operation
- Side blanking for 2 & 1 sided installations



Flame Projection Technology



Video

**Specification**

Fire Dimensions: mm	H 375 x W 1430 x D 275
Heat Output	1.0kW - 2.0kW

**ER 1100**

Electriflame VR Built-In 3 Sided Glass Fire

**Features**

- Flame Projection Technology
- 3 sided glass fire
- Customisable fuel effect
- Silver birch ceramic logs
- Crystal ash embers
- Single or dual colour flame
- LED brightness control
- Thermostatic remote & manual control operation
- Side blanking for 2 & 1 sided installations



Flame Projection Technology



**Specification**

Fire Dimensions: mm	H 374 x W 1130 x D 275
Heat Output	1.0kW - 2.0kW



Video





Electrifiame VR Built-In 3 Sided Glass Fire



Video



**Features**

- Flame Projection Technology
- 3 sided glass fire
- Customisable fuel effect
- Silver birch ceramic logs
- Crystal ash embers
- Single or dual colour flame
- LED brightness control
- Thermostatic remote & manual control operation
- Side blanking for 2 & 1 sided installations

**Optional Extras**

Woodland logs fuel effect



**Specification**

Fire Dimensions: mm	H 374 x W 780 x D 275
Heat Output	0.8kW - 1.6kW



Electrifiame VR 3 Sided Glass Fire Wall Mounted Illumia Suite



Video



**Features**

- Flame Projection Technology
- 3 sided glass fire
- Dimmable LED surround lighting
- Customisable fuel effect
- Silver birch ceramic logs
- Crystal ash embers
- Single or dual colour flame
- LED brightness control
- Thermostatic remote & manual control operation
- Includes wall fixing bracket

**Optional Extras**

Woodland logs fuel effect



**Specification**

Suite Dimensions: mm	H 721 x W 1400 x D 406
Heat Output	1.0kW - 2.0kW
Suite Finish Painted	<input type="checkbox"/> Smooth White

# ER VOLARE 1100

Electrifiame VR Wall Mounted Illumia Suite

## Features

- Flame Projection Technology
- 3 sided glass fire
- Dimmable LED surround lighting
- Customisable fuel effect
- Silver birch ceramic logs
- Crystal ash embers
- Single or dual colour flame
- LED brightness control
- Thermostatic remote & manual control operation
- Includes wall fixing bracket



Flame Projection Technology



## Specification

Suite Dimensions: mm	H 721 x W 1595 x D 406
Heat Output	1.0kW - 2.0kW
Suite Finish Painted	<input type="checkbox"/> Smooth White



Video

# ER COMMODUS

Electriflame VR Wall Inset Fire



Video



Black Nickel & Black

## Features

- Flame Projection Technology
- Glass fronted fire
- Customisable fuel effect
- Silver birch ceramic logs
- Crystal ash embers
- Single or dual colour flame
- LED brightness control
- Thermostatic remote & manual control operation
- Fascia option available



Commodus fascia-less installation



## Specification

Fire Dimensions: mm	H 330 x W 981 x D 169
Fascia Dimensions: mm	H 540 x W 1200 x D 19
Heat Output	0.8kW - 1.6kW

## Finishes

Steel Fabricated Fascia  
Dual Metallic



# ER VICHY

Electriflame VR Wall Inset Fire



Video



Satin Champagne

## Features

- Flame Projection Technology
- Glass fronted fire
- Customisable fuel effect
- Silver birch ceramic logs
- Crystal ash embers
- Single or dual colour flame
- LED brightness control
- Thermostatic remote & manual control operation



Satin Silver



## Specification

Dimensions: mm	H 523 x W 1653 x D 87
Heat Output	0.8kW - 1.6kW

## Finishes

Steel Fabricated Fascia  
Brushed Metallic





Video



**Features**

- Flame Projection Technology
- Glass fronted fire
- Customisable fuel effect
- Woodland ceramic logs
- Crystal ash embers
- Single or dual colour flame
- LED brightness control
- Thermostatic remote & manual control operation
- Includes wall fixing bracket



**Specification**

Dimensions: mm	H 519 x W 1102 x D 201
Heat Output	0.8kW - 1.6kW

**Finish**

Steel Fabricated & Glass Fascia Dual Finish Brushed Metallic	Satin Silver & Black Glass
--	----------------------------



Video



**Features**

- Flame Projection Technology
- Glass fronted fire
- Customisable fuel effect
- Silver birch ceramic logs
- Crystal ash embers
- Single or dual colour flame
- LED brightness control
- Thermostatic remote & manual control operation
- Includes wall fixing bracket
- Wall inset option



**Specification**

Dimensions: mm	H 570 x W 1400 x D 90
Heat Output	0.8kW - 1.6kW



Satin Silver & Black

**Finishes**

Steel Fabricated Fascia Dual Finished Brushed Metallic Black Painted	Satin Silver & Black Satin Champagne & Black
---	---



Chrome & Black Nickel

## ER ACERO

Electriflame VR Hearth Inset Fire

### Features

- Aspirational 26 inch fascia
- Flame Projection Technology
- Extra wide glass fronted fire
- Customisable fuel effect
- Silver birch ceramic logs
- Crystal ash embers
- Single or dual colour flame
- LED brightness control
- Thermostatic remote & manual control operation



THERMO-STATIC



7 DAY TIMER



ENERGY SAVING



ISO FLAME



FLAME FUSION



Chrome & Satin Silver

Flame Projection Technology



Video

### Specification

Dimensions: mm	H 655 x W 657 x D 67
Heat Output	0.8kW - 1.6kW
Finishes	<input type="checkbox"/> Chrome & Satin Silver <input type="checkbox"/> Chrome & Black Nickel
Steel Fabricated Fascia	
Dual Finished	
Twin Metallic	



Video



**Features**

- Flame Projection Technology
- Extra wide glass fronted fire
- Customisable fuel effect
- Silver birch ceramic logs
- Crystal ash embers
- Single or dual colour flame
- LED brightness control
- Thermostatic remote & manual control operation



Satin Silver

**Finishes**

- Steel Fabricated Fascia  
Brushed Metallic
- Satin Silver
  - Satin Champagne

**Specification**

Dimensions: mm	H 602 x W 544 x D 90
Heat Output	0.75kW - 1.5kW



Video



**Features**

- Flame Projection Technology
- Extra wide glass fronted fire
- Customisable fuel effect
- Silver birch ceramic logs
- Crystal ash embers
- Single or dual colour flame
- LED brightness control
- Thermostatic remote & manual control operation



**Finishes**

- Steel Fabricated Fascia  
Brushed Metallic
- Satin Champagne

**Specification**

Dimensions: mm	H 602 x W 544 x D 90
Heat Output	0.75kW - 1.5kW



# H3D HOLOGRAM GENESIS

Electriflame H3D Smart Stove

## Features

- Holographic Im-Mesh 3D Technology<sup>®</sup>
- Multi Flame Projection Technology<sup>®</sup>
- Living Ember Bed Technology<sup>®</sup>
- Tough steel construction
- Curved design
- Woodland ceramic logs
- 16 pre-set colours/100+ custom/Animation mode
- LED brightness control
- Thermostatic remote & manual control operation
- Amazon Alexa and Google Assistant compatible
- Decorative flue pipe available



**CELSI SMART APP**  
 Feature-rich and simple to operate. Control your fire from your smart phone or tablet with full handset functionality.



The Holographic Im-Mesh 3D technology offers an extensive number of colour options and combinations. Explore dancing flame witchery and smouldering logs with Living Ember Bed Technology, a desirable effect at the forefront of the electric stoves market.

This exciting new generation of electric fires features patented technologies. It is economical to run with high quality LEDs. The heater is thermostatically controlled with settings options. The fire is simple to use and can be operated manually, by remote control, or via WiFi using our dedicated Celsi app. The flame picture can be used in isolation to the heat, and is a popular choice when no heat is required during the summer months, offering exceptionally low running costs.

Instant heat can be applied to a room at anytime with full thermostatic control.



Video

## Specification

Dimensions: mm	H 800 x W 500 x D 400
Heat Output	1.0kW – 2.0kW
Finish Steel Fabricated Painted	Black



Scan the QR code to download our app





Video

**Features**

- Flame Projection Smart Technology
- 3 sided glass stove
- Customisable fuel effect
- Woodland ceramic logs
- Crystal ash embers
- 16 pre-set colours/100+ custom/Animation mode
- LED brightness control
- Thermostatic remote & manual control operation
- Amazon Alexa and Google Assistant compatible
- Decorative flue pipe available



**CELSI SMART APP**  
 Feature-rich and simple to operate. Control your fire from your smart phone or tablet with full handset functionality.



Celsi Smart Fires have 16 pre-set ambient colour modes, and over 100+ multi colour combinations to customise the light ambience on flames, logs, and ember beds. To simplify your choice you can relax with a slow cycle through the colour spectrum in our fully immersive Animation mode.



Scan the QR code to download our app



**Specification**

Dimensions: mm	H 800 x W 500 x D 400
Heat Output	1.0kW – 2.0kW
Finish Steel Fabricated Painted	Black

**Optional Extras**

- Decorative Steel Flue Pipe Accessories



Video



**Specification**

Dimensions: mm	H 1095 x W 500 x D 400
Heat Output	1.0kW – 2.0kW
Finish Steel Fabricated Painted	Black







## STRATFORD

### Electriflame VR Smart Stove

#### Features

- Flame Projection Smart Technology
- Tough steel body stove
- Customisable fuel effect
- Woodland ceramic logs
- Crystal ash embers
- 16 pre-set colours/100+ custom/Animation mode
- LED brightness control
- Thermostatic remote & manual control operation
- Amazon Alexa and Google Assistant compatible
- Decorative flue pipe available



**CELSI SMART APP**  
Feature-rich and simple to operate. Control your fire from your smart phone or tablet with full handset functionality.



Celsi Smart Fires have 16 pre-set ambient colour modes, and over 100+ multi colour combinations to customise the light ambience on flames, logs, and ember beds. To simplify your choice you can relax with a slow cycle through the colour spectrum in our fully immersive Animation mode.



Video

#### Specification

Dimensions: mm	H 590 x W 500 x D 330
Heat Output	1.0kW – 2.0kW
Finish	Black
Steel Fabricated Painted	



Scan the QR code to download our app

Electriflame VR Stove

**Features**

- Flame Projection Technology
- Tough steel body
- Curved door design
- Customisable fuel effect
- Silver birch ceramic logs
- Crystal ash embers
- Single or dual colour flame
- LED brightness control
- Thermostatic remote & manual control operation



**Optional Extras**

- Woodland ceramic logs
- Decorative Steel Flue Pipe Accessories



**Specification**

Dimensions: mm	H 606 x W 532 x D 372
Heat Output	1.0kW - 2.0kW
Finish	Black
Steel Fabricated Painted	



Video



Video



**Features**

- Flame Projection Technology
- Tough steel body
- Customisable fuel effect
- Silver birch ceramic logs
- Crystal ash embers
- Single or dual colour flame
- LED brightness control
- Thermostatic remote & manual control operation



**Optional Extras**

- Woodland ceramic logs
- Decorative Steel Flue Pipe Accessories



**Finish**

Steel Fabricated  
Painted



Black

**Specification**

Dimensions: mm	H 582 x W 430 x D 389
Heat Output	0.75kW - 1.5kW



Video



**Features**

- Flame Projection Technology
- Tough steel body
- Customisable fuel effect
- Silver birch ceramic logs
- Crystal ash embers
- Single or dual colour flame
- LED brightness control
- Thermostatic remote & manual control operation



**Optional Extras**

- Woodland ceramic logs
- Decorative Steel Flue Pipe Accessories



**Finish**

Steel Fabricated  
Painted



Black

**Specification**

Dimensions: mm	H 595 x W 471 x D 359
Heat Output	0.75kW - 1.5kW

# EXO PRESTIGE

## Electriflame XD Wall Mounted Fire

### Features

- Glass fronted fire
- High definition effect
- Extra deep 3D coals
- Relaxing smoky flames
- LED brightness control
- Thermostatic remote & manual control operation
- Includes wall fixing bracket



Atmospheric flame ascension



### Specification

Dimensions: mm	H 600 x W 1100 x D 150
Heat Output	0.75kW – 1.5kW
Finish	 Prestige Brown
Natural Marble	



Video

# EXO BLACK GLASS



Video

Electriflame XD Wall Mounted Fire

Black Glass 1300



## Features

- Glass fronted fire
- High definition effect
- Extra deep 3D coals
- Relaxing smoky flames
- LED brightness control
- Thermostatic remote & manual control operation
- Includes wall fixing bracket
- Available in two sizes



Black Glass 1100



## Specification

Dimensions: mm	H 600 x W 1300 & 1100 x D 126
Heat Output	0.75kW - 1.5kW

## Finish



# EXO ROYAL BOTTICINO



Video

Electriflame XD Wall Mounted Fire



## Features

- Glass fronted fire
- High definition effect
- Extra deep 3D coals
- Relaxing smoky flames
- LED brightness control
- Thermostatic remote & manual control operation
- Includes wall fixing bracket



## Specification

Dimensions: mm	H 600 x W 1100 x D 150
Heat Output	0.75kW - 1.5kW

## Finish

Natural Marble



# EXO TRAVERTINE

Electriflame XD Wall Mounted Fire



Video

Travertine 1100



## Features

- Glass fronted fire
- High definition effect
- Extra deep 3D coals
- Relaxing smoky flames
- LED brightness control
- Thermostatic remote & manual control operation
- Includes wall fixing bracket
- Available in two sizes



Travertine 1300



## Specification

Dimensions: mm	H 625 x W 1300 & 1100 x D 150
Heat Output	0.75kW - 1.5kW

## Finish

Natural  Travertine

# EXO PIANO BLACK

Electriflame XD Wall Mounted Fire



Video



## Features

- Glass fronted fire
- High definition effect
- Extra deep 3D coals
- Relaxing smoky flames
- LED brightness control
- Thermostatic remote & manual control operation
- Includes wall fixing bracket



## Specification

Dimensions: mm	H 600 x W 1300 x D 150
Heat Output	0.75kW - 1.5kW

## Finish

Glossy Painted  Black

# EXO CAMBER

Electriflame XD Hearth Inset Fire



Video



Satin Champagne

### Features

- Glass fronted fire
- Customisable fuel effect
- Silver birch ceramic logs
- Crystal ash embers
- Single or dual colour flame
- LED brightness control
- Thermostatic remote & manual control operation



### Optional Extras

75mm Spacer frame  
For flat wall installation



Satin Silver

Black Textured

### Finishes

Anodised Aluminium Fascia  
Brushed Metallic  
Textured Black Paint

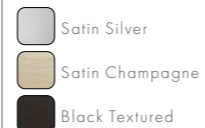

### Specification

Dimensions: mm	H 619 x W 537 x D 105
Heat Output	0.75kW - 1.5kW

# EXO DECADENCE

Electriflame XD Hearth Inset Fire



Video



Gold

### Features

- Glass fronted fire
- Customisable fuel effect
- Silver birch ceramic logs
- Crystal ash embers
- Single or dual colour flame
- LED brightness control
- Thermostatic remote & manual control operation



### Optional Extras

75mm Spacer frame  
For flat wall installation



Chrome

Black Nickel

### Specification

Dimensions: mm	H 630 x W 528.5 x D 122
Heat Output	0.75kW - 1.5kW

### Finishes

High Quality Cast Iron Fascia  
Metallic Plated

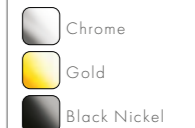



Video



Satin Silver

**Features**

- Glass fronted fire
- Customisable fuel effect
- Silver birch ceramic logs
- Crystal ash embers
- Single or dual colour flame
- LED brightness control
- Thermostatic remote & manual control operation



**Optional Extras**

75mm Spacer frame  
For flat wall installation



Black

**Specification**

Dimensions: mm	H 610 x W 537 x D 105
Heat Output	0.75kW - 1.5kW

**Finishes**

Steel Fabricated Fascia  
Brushed Metallic  
or Smooth Black Paint

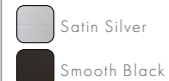

Video



Black & Chrome

**Features**

- Glass fronted fire
- Customisable fuel effect
- Silver birch ceramic logs
- Crystal ash embers
- Single or dual colour flame
- LED brightness control
- Thermostatic remote & manual control operation



**Optional Extras**

75mm Spacer frame  
For flat wall installation



Black & Gold

**Specification**

Dimensions: mm	H 612 x W 528 x D 130
Heat Output	0.75kW - 1.5kW

**Finishes**

High Quality Cast Iron Fascia  
Dual Metallic Plated

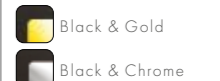





Video



Black Nickel & Black

**Features**

- Glass fronted fire
- Customisable fuel effect
- Silver birch ceramic logs
- Crystal ash embers
- Single or dual colour flame
- LED brightness control
- Thermostatic remote & manual control operation



**Optional Extras**

75mm Spacer frame  
For flat wall installation



Satin Silver & Chrome

**Finishes**

Steel Fabricated Fascia  
Dual Metallic



**Specification**

Dimensions: mm	H 599 x W 498 x D 129
Heat Output	0.75kW - 1.5kW



Video



Black

**Features**

- Glass fronted fire
- Customisable fuel effect
- Silver birch ceramic logs
- Crystal ash embers
- Single or dual colour flame
- LED brightness control
- Thermostatic remote & manual control operation



**Optional Extras**

75mm Spacer frame  
For flat wall installation



Brass



Chrome

**Finishes**

Quality Cast Trim and Fret  
Solid Brass or Cast Iron  
Black point detail

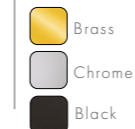

**Specification**

Dimensions: mm	H 595 x W 490 x D 100
Heat Output	0.75kW - 1.5kW



Video



Satin Silver

**Features**

- Glass fronted fire
- Customisable fuel effect
- Silver birch ceramic logs
- Crystal ash embers
- Single or dual colour flame
- LED brightness control
- Thermostatic remote & manual control operation



**Optional Extras**

75mm Spacer frame  
For flat wall installation



Brass

Black

**Finishes**

Steel Fabricated Trim  
Solid Brass or Cast Iron Fret  
Metallic or Smooth Black Paint

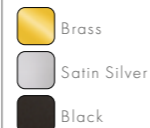

**Specification**

Dimensions: mm	H 595 x W 490 x D 100
Heat Output	0.75kW - 1.5kW



Video



Satin Silver

**Features**

- Glass fronted fire
- Customisable fuel effect
- Silver birch ceramic logs
- Crystal ash embers
- Single or dual colour flame
- LED brightness control
- Thermostatic remote & manual control operation



**Optional Extras**

75mm Spacer frame  
For flat wall installation



Brass

**Finishes**

Quality Cast Trim and Fret  
Solid Brass or Cast Iron  
Black paint detail

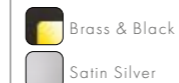

**Specification**

Dimensions: mm	H 650 x W 535 x D 100
Heat Output	0.75kW - 1.5kW

Metal 2



## EXO METAL 1 & 2

Electr stove XD Stove

### Features

- Tough steel body & door
- High definition effect
- Extra deep 3D coals
- Relaxing smoky flames
- LED brightness control
- Thermostatic remote & manual control operation



THERMO-STATIC



8 HOUR TIMER



ENERGY SAVING



ISO FLAME



Metal 1



METAL 1  
Video



METAL 2  
Video

### Specification

Dimensions: mm	Metal 1 Metal 2	H 579 x W 430 x D 332 H 587 x W 524 x D 295
Heat Output		1.0kW - 2.0kW
Finish	Steel Fabricated Body	 Black

### Optional Extras

- Woodland logs fuel effect
- Decorative Steel Flue Pipe Accessories

# EXO GLASS 1 & 2

Electr stove XD Stove

## Features

- Tough steel body
- Glass door & stove top
- High definition effect
- Extra deep 3D coals
- Relaxing smoky flames
- LED brightness control
- Thermostatic remote & manual control operation



Glass 2



GLASS 2  
Video



Glass 1

## Specification

Dimensions: mm	Glass 1 Glass 2	H 583 x W 430 x D 334 H 591 x W 524 x D 295
Heat Output		1.0kW – 2.0kW
Finish	Steel Fabricated Body Glass Door	Black Glass & Chrome



GLASS 1  
Video

# FMK RAPTURE

Flamonik Wall Mounted Fire



Video



## Features

- Flat glass fascia
- Distinctive flame effect
- Raised log fuel bed
- Thermostatic remote & manual control operation
- Includes wall fixing bracket



Magenta



Blue



Amber



## Specification

Dimensions: mm	H 440 x W 686 x D 110
Heat Output	0.75kW - 1.5kW

## Finish



Black Glass

# FMK ENCHANT

Flamonik Wall Mounted Fire



Video



## Features

- Curved glass fascia
- Enchanting smoky flame effect
- Raised log fuel bed
- Thermostatic remote & manual control operation
- Includes wall fixing bracket



Magenta



Blue



Amber



## Specification

Dimensions: mm	H 441 x W 916 x D 126
Heat Output	0.75kW - 1.5kW

## Finish



Black Glass

# ACCENT TRADITIONAL

Hearth Inset Fire



Video



## Features

- Open fire experience
- Lively ribbon flame effect
- Coal effect fuel bed
- LED brightness control
- Thermostatic remote & manual control operation



Chrome

## Finishes

Steel Fabricated  
Metallic Plated Trim

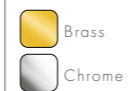

## Specification

Dimensions: mm	H 595 x W 490 x D 35
Heat Output	1.0kW - 2.0kW

# ACCENT INFUSION

Hearth Inset Fire



Video



## Features

- Open fire experience
- Lively ribbon flame effect
- Coal effect fuel bed
- LED brightness control
- Thermostatic remote & manual control operation



Brass & Black



Black & Chrome

## Finishes

Steel Fabricated Fascia  
Dual Metallic & Painted



## Specification

Dimensions: mm	H 595 x W 498 x D 83
Heat Output	1.0kW - 2.0kW

ULTIFLAME® VR

Firebeam Suites 8-15

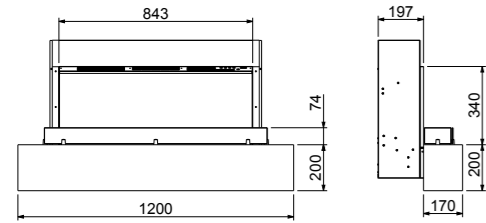

FIREBEAM 800 ILLUMIA

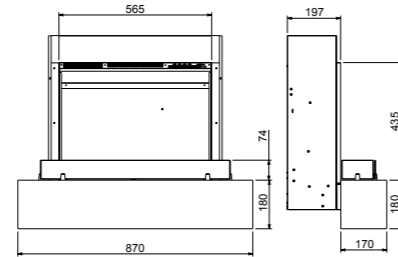

FIREBEAM 600 ILLUMIA

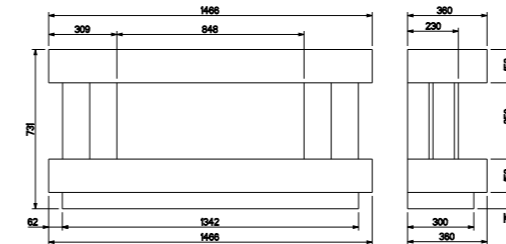

GEMMA 800 ILLUMIA

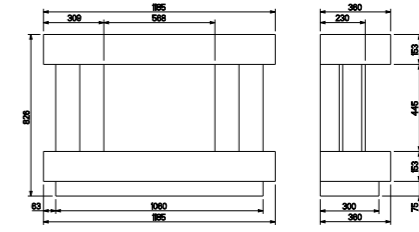

GEMMA 600 ILLUMIA

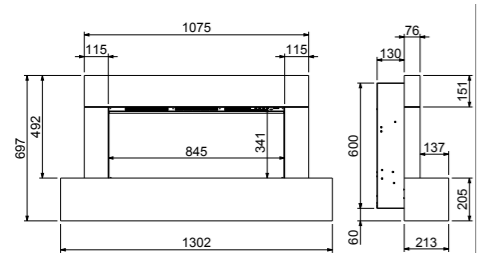

FIREBEAM XL800 ILLUMIA

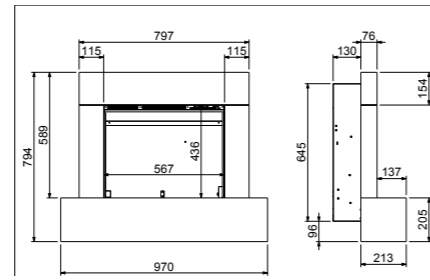

FIREBEAM XL600 ILLUMIA

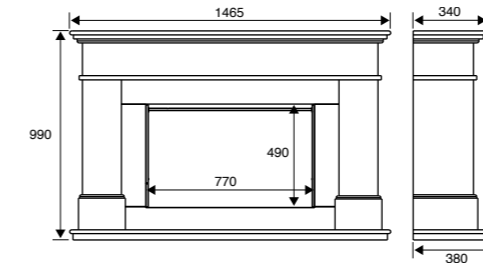

ADOUR ALEESIA ILLUMIA

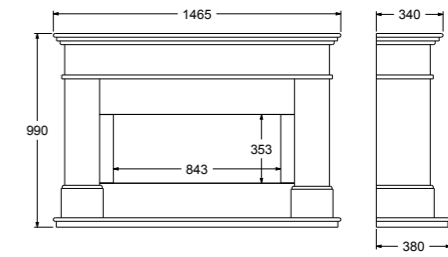

ADOUR ELITE ILLUMIA

Freestanding Suites 16-33

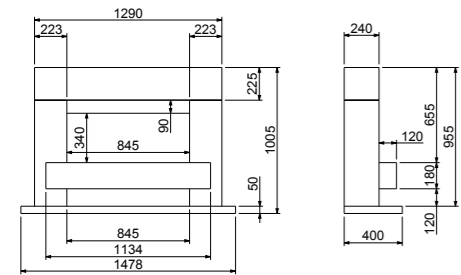

LUMINAIRE 800 ILLUMIA

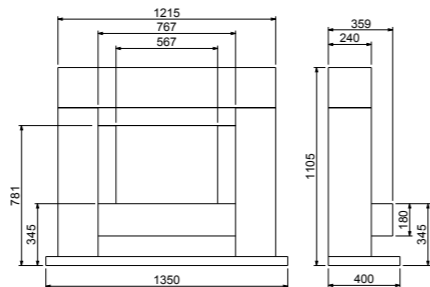

LUMINAIRE 600 ILLUMIA

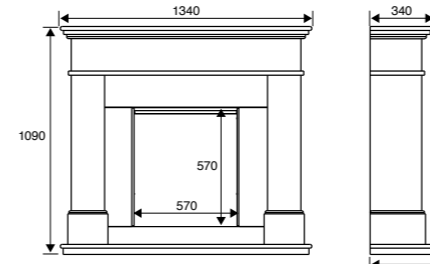

ADOUR ASENCIO ILLUMIA

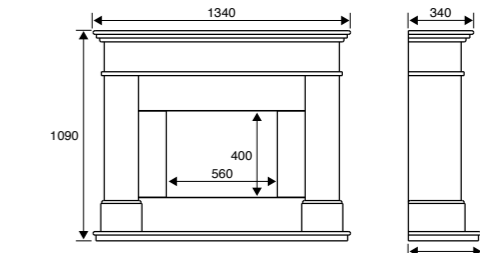

ADOUR ILLUMIA



SKYFALL 800 ILLUMIA

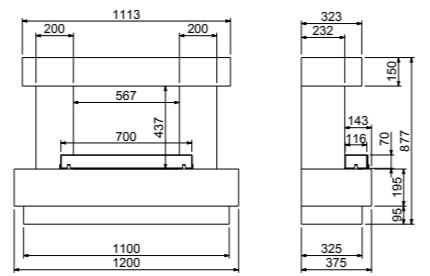

SKYFALL 600 ILLUMIA

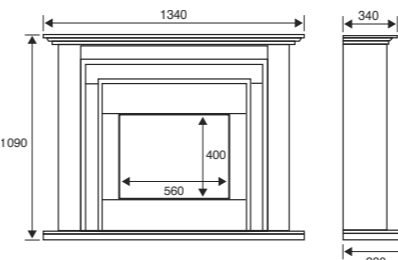

CANELO ILLUMIA

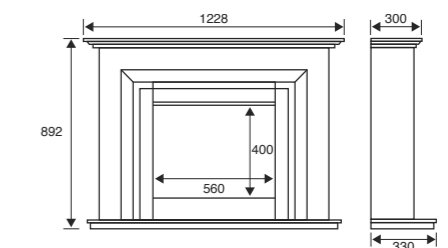

ELARA

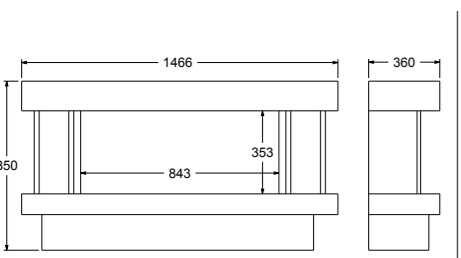

ORBITAL 800 ILLUMIA

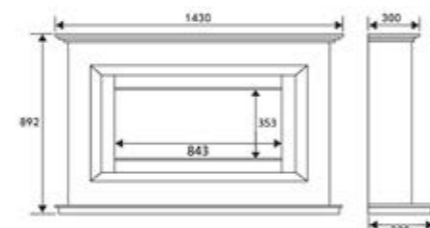

VEGA

ULTIFLAME® VR

Inset Limestone Suites 34-40



PARADA ELITE ILLUMIA

AVIGNON ELITE

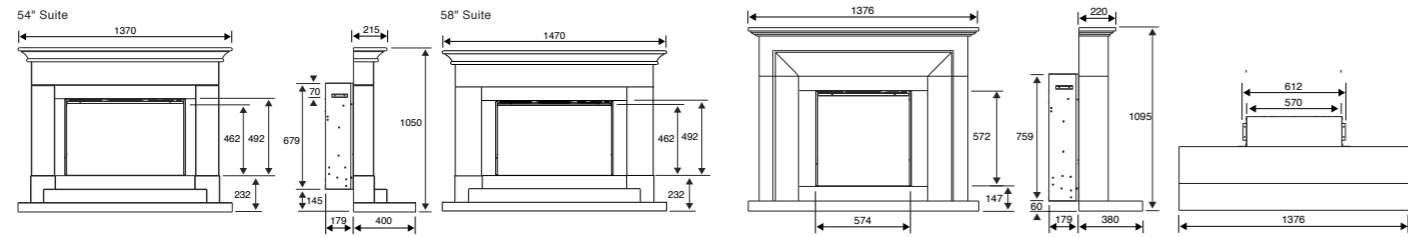

ALEESIA ILLUMIA

ASECCIO

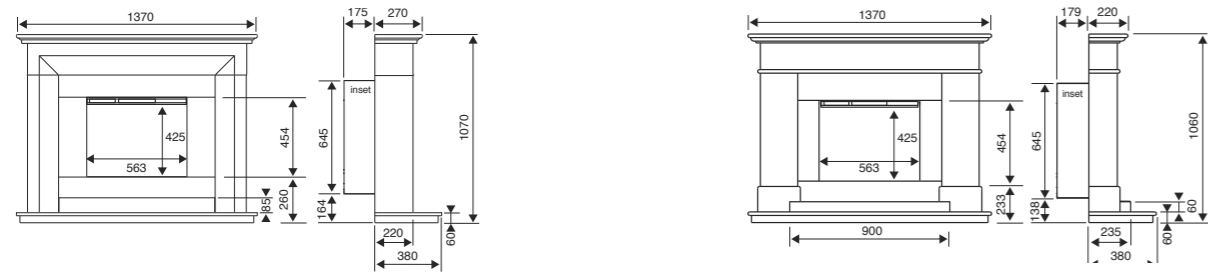

ANGELO

BOTICELLI

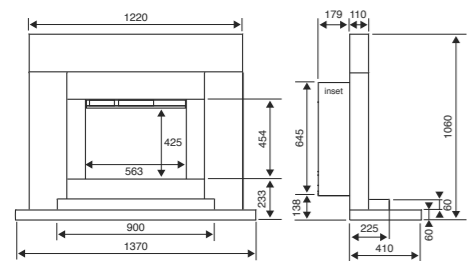

PABLO

Wall Inset 40-49

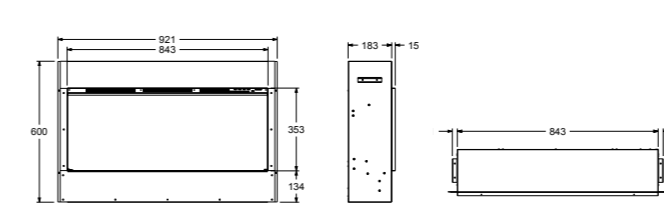

ELITE

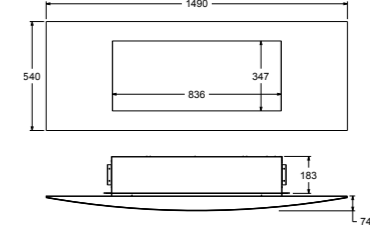

VICHY

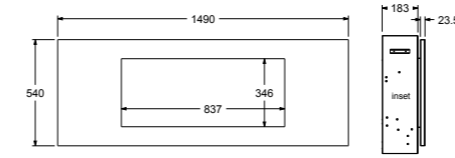

METZ

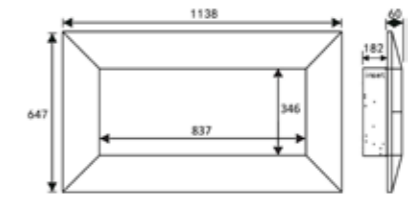

INSTINCT

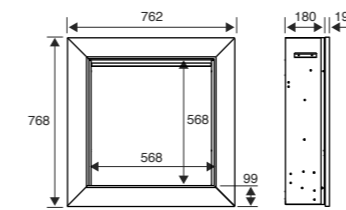

EVORA ASECCIO

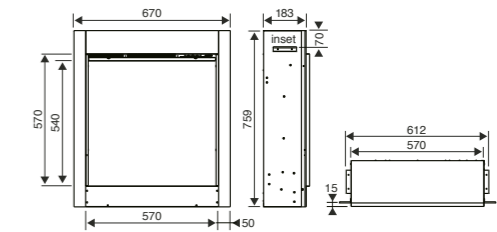

ASECCIO

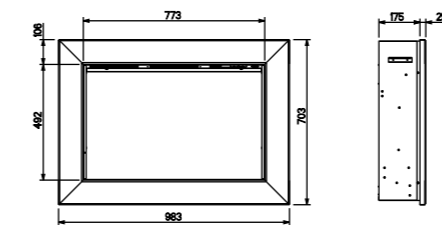

VADER ALEESIA

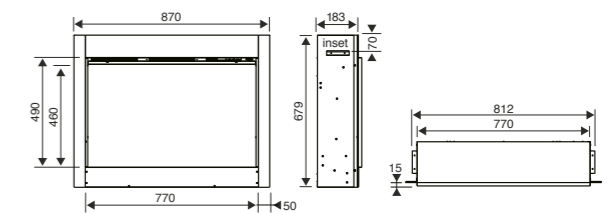

ALEESIA

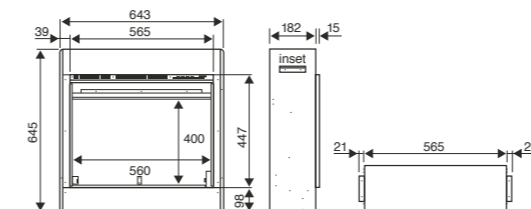

CELENA

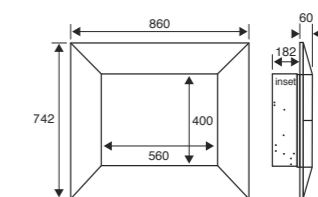

IMPULSE



ULTIFLAME® VR

Hearth Inset Fires 50-57

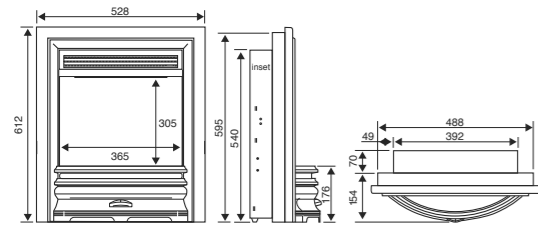

ARCADIA

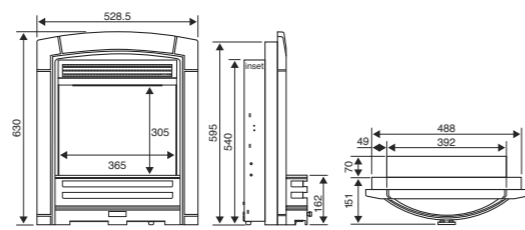

DECADENCE

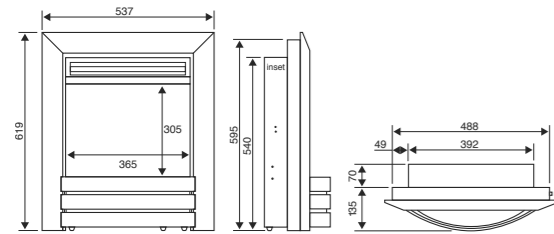

CAMBER

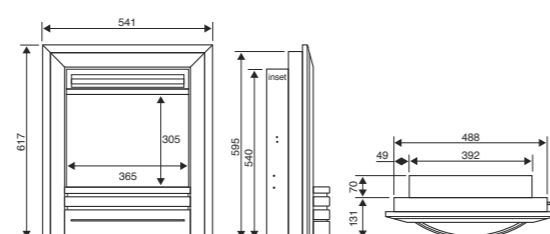

FRONTIER

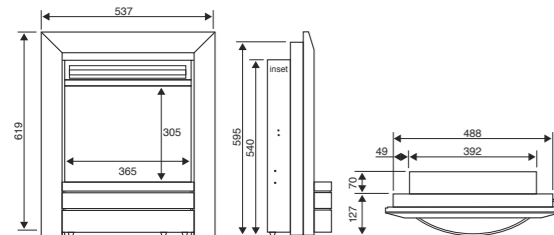

ESSENCE

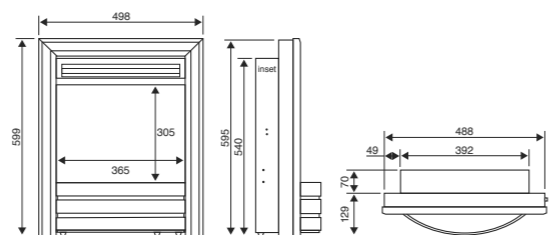

DESIGNER

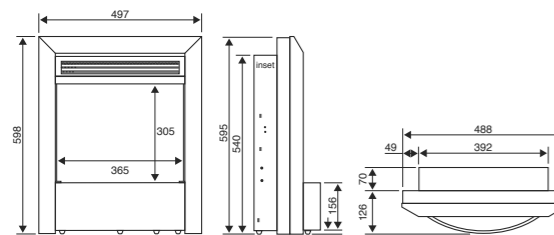

ENDURA

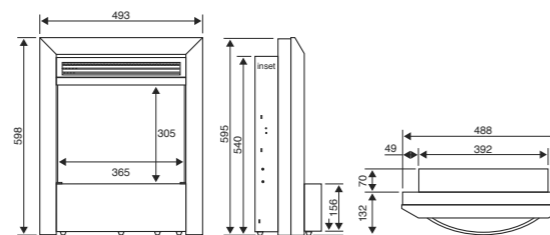

CONTEMPORARY

ELECTRIFLAME® VR

Freestanding Suites 58-67

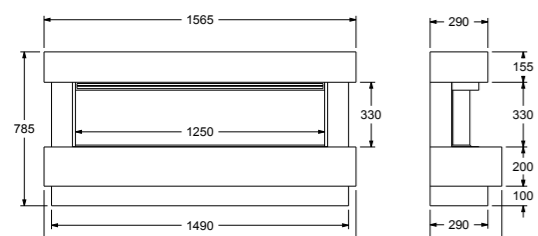

QUANTUM s1250

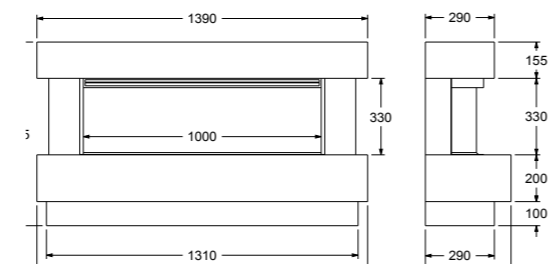

QUANTUM s1000

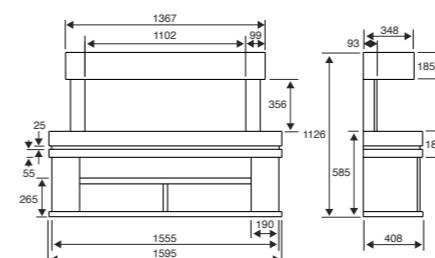

MEDIA 1100 ILLUMIA

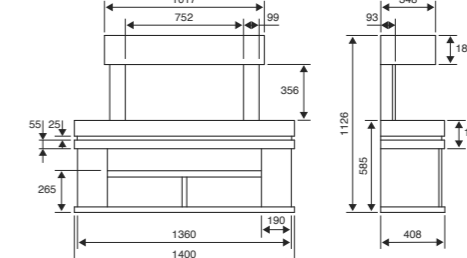

MEDIA 750 ILLUMIA

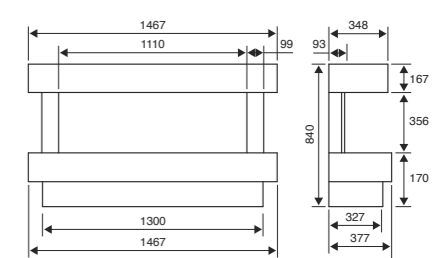

CARINO 1100 ILLUMIA

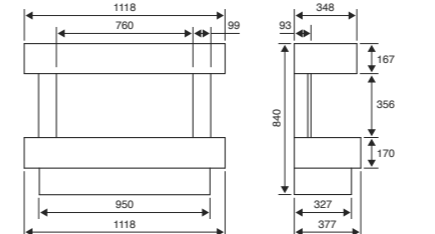

CARINO 750 ILLUMIA

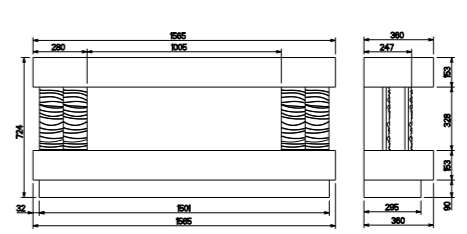

GEMMA 1000 ILLUMIA

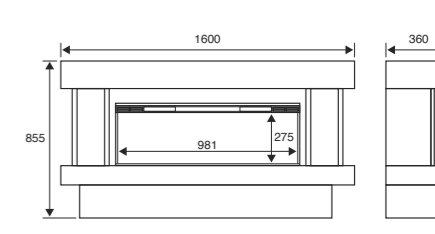

ORBITAL 1000 ILLUMIA

Built-In 3 Sided Glass Fires 68-78

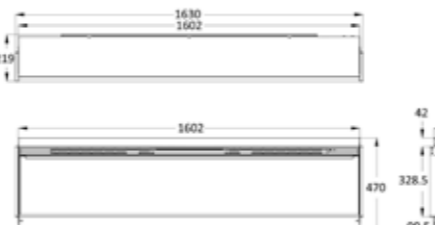

COMMODUS s1600



COMMODUS s1250

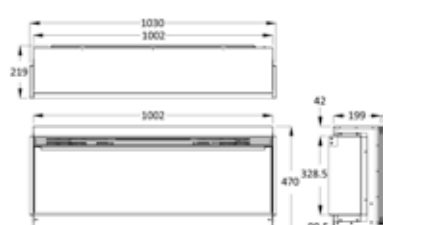

COMMODUS s1000

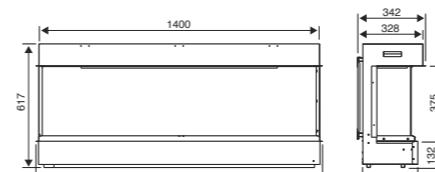

1400

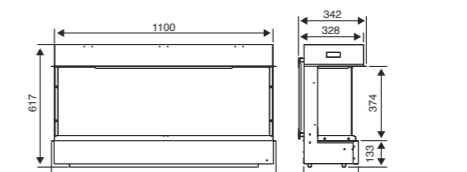

1100

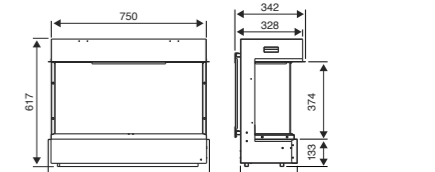

750

Wall Mounted 3 Sided Suites 79-81

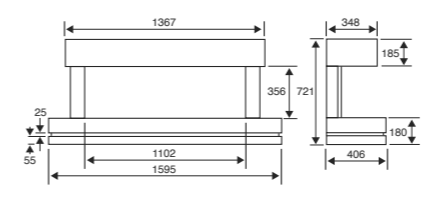

VOLARE 1100 ILLUMIA

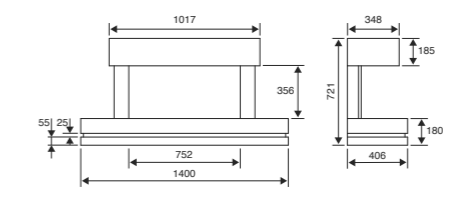

VOLARE 750 ILLUMIA

ELECTRIFLAME® VR

Wall Inset Fires 82-83

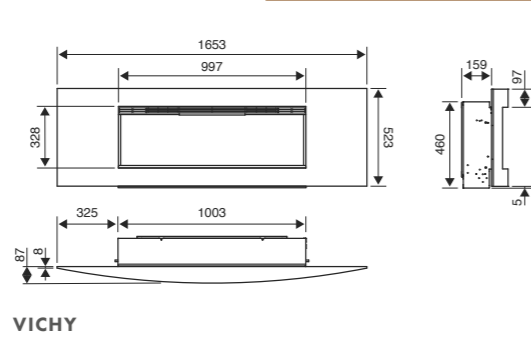
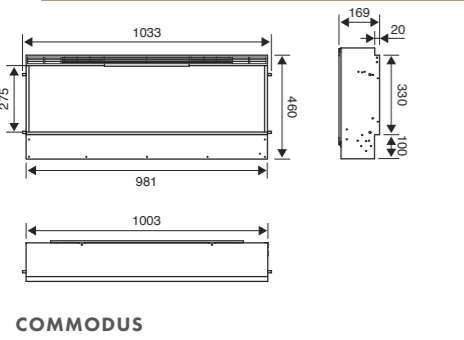
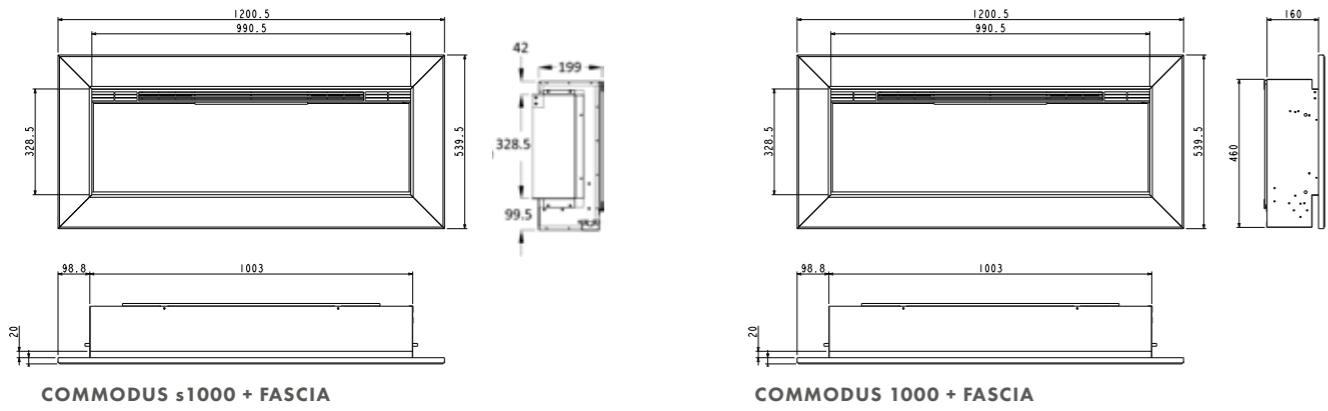

Wall Mounted Fires 84-85

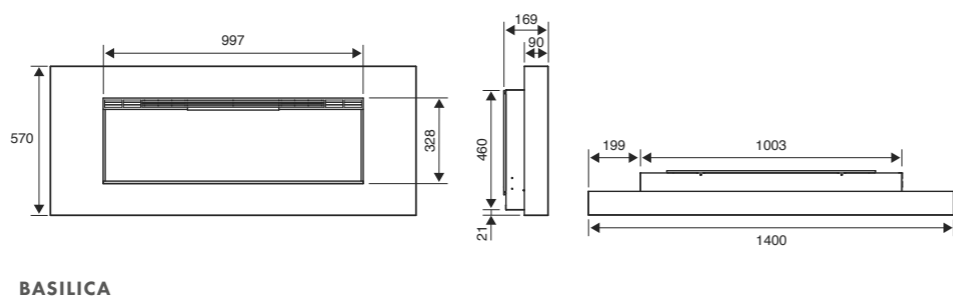
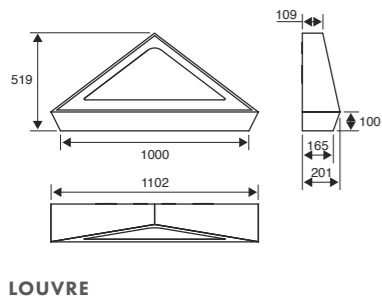

Hearth Inset Fires 86-89

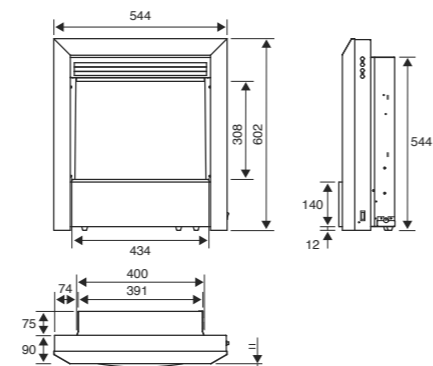
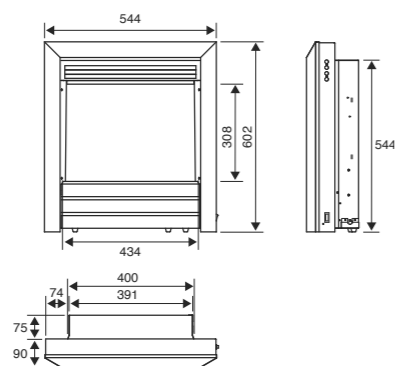
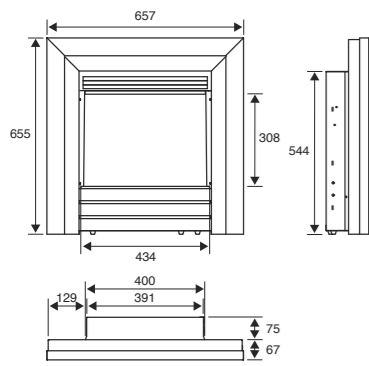

Stoves 90-99

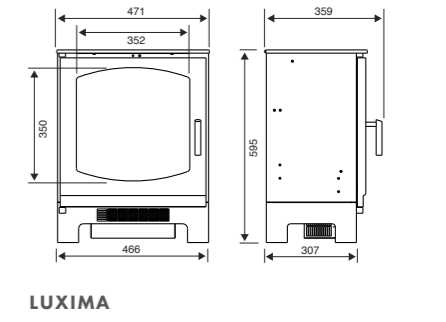
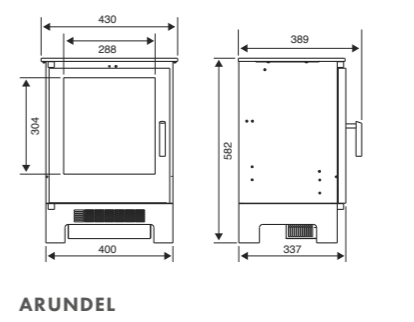
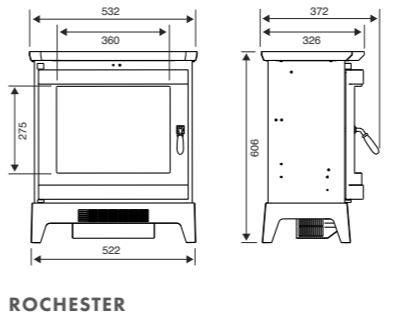
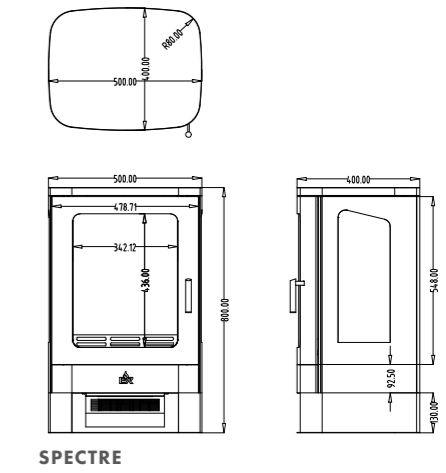
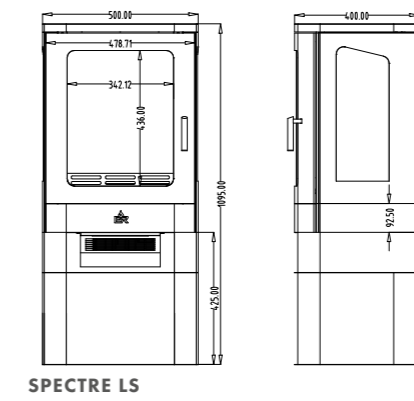
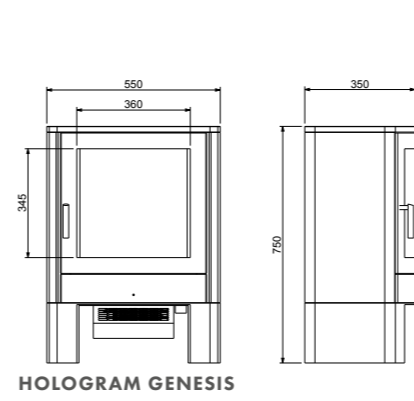

ELECTRIFLAME® XD

Wall Mounted Fires 100-105

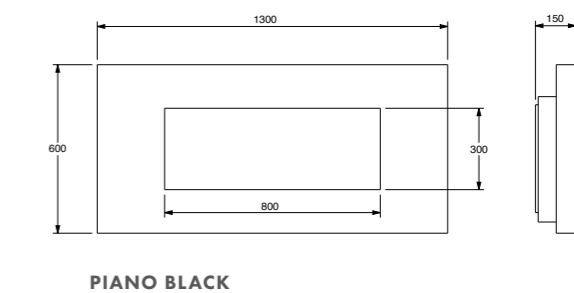
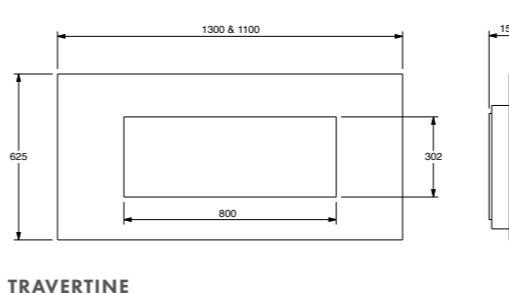
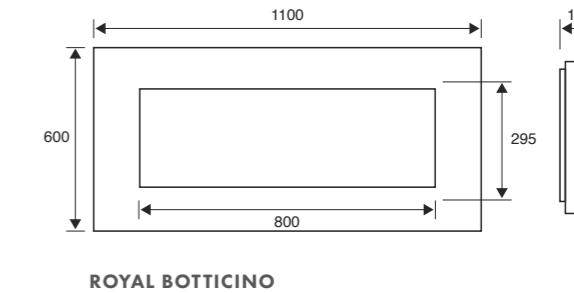
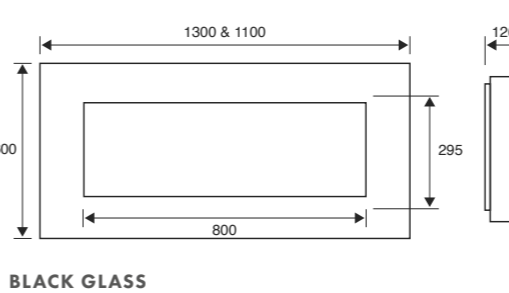
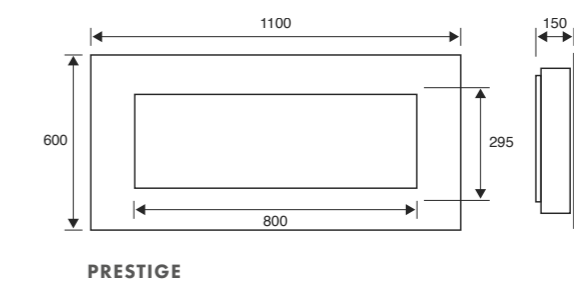
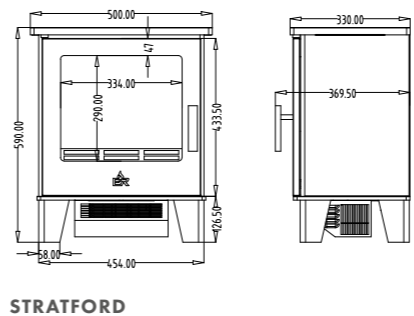

ELECTRIFLAME® XD

Hearth Inset Fires 106-115

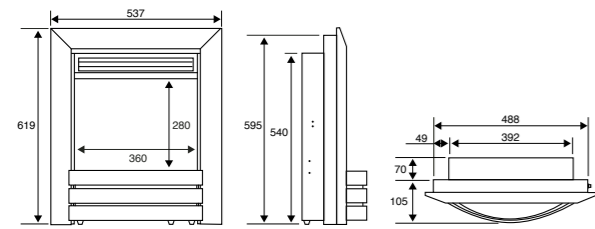

CAMBER

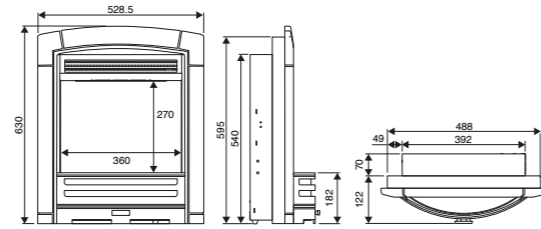

DECADENCE

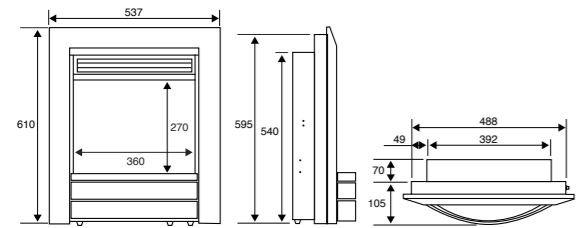

ESSENCE

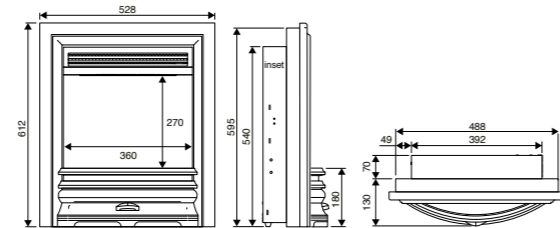

ARCADIA

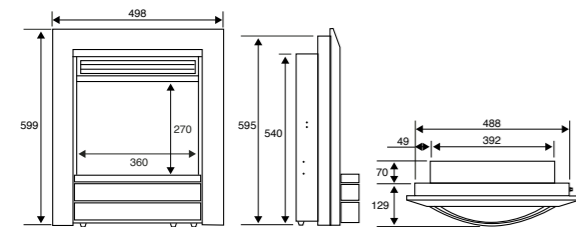

SIGNATURE

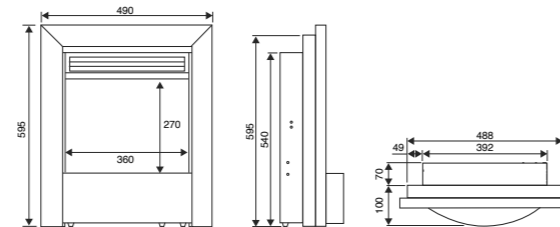

DAISY

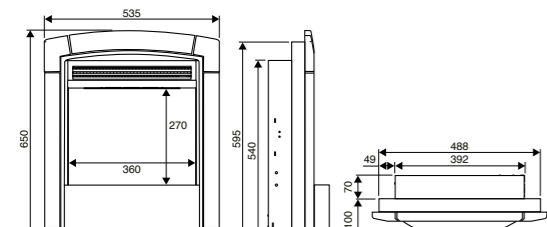

CARESS

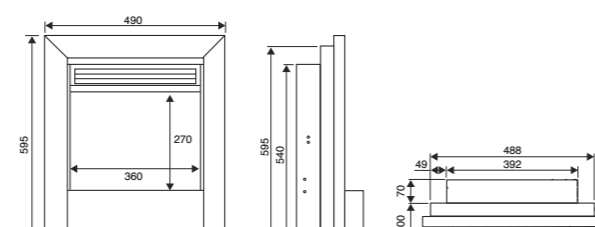

BAUHAUS

ELECTRISTOVE® XD

Stoves 116-119

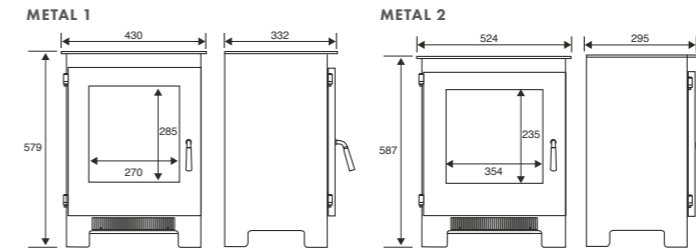

ELECTRISTOVE METAL

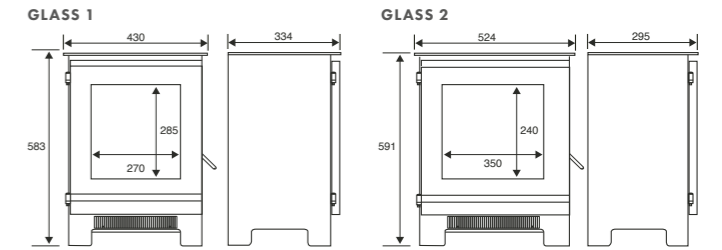

ELECTRISTOVE GLASS

FLAMONIK

Wall Outlet 120-121

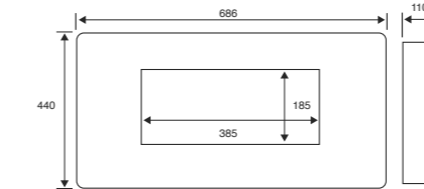

RAPTURE

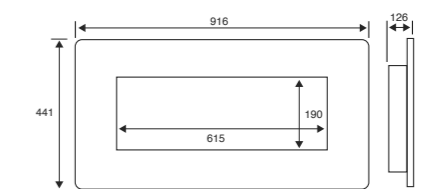

ENCHANT

ACCENT

Hearth Inset 122-123

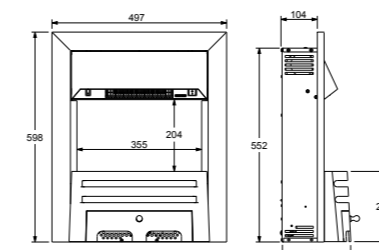

ACCENT TRADITIONAL

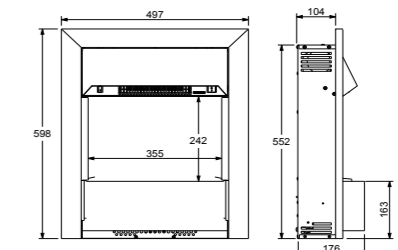

ACCENT INFUSION



#### DISCLAIMER

Our policy is one of constant development and improvement. We therefore reserve the right to revise designs and specifications of our products without formal notice, patents pending. We always recommend our products be viewed in an approved showroom before purchase. Whilst we have taken every care in the preparation of this brochure it is not intended to replace the installation manual which provides more detailed information.

Photography is for illustration purposes only and although every effort has been made to ensure accurate reproduction of typical installations and flame pictures they may vary according to fire model and flue types.

We accept no liability for any loss or damage arising directly or indirectly from the use of this brochure.

We recommend that all our fires are used in conjunction with central heating and not as a primary source of heat.

In the interests of personal safety a suitable fireguard is recommended when children, the elderly and the infirm are present.

This brochure is copyright 2023 and must not be reproduced in whole or in any part without prior written permission.



BFM Europe Ltd, Gordon Banks Drive,  
Trentham Lakes, Stoke-on-Trent ST4 4TJ

Tel: 01782 339000

Email: [sales@bfm-europe.com](mailto:sales@bfm-europe.com)

[www.celsielectricfires.co.uk](http://www.celsielectricfires.co.uk)

Go direct to the Celsi website on your smart phone or tablet device and use the app to scan the black and white QR codes shown on each page. Alternatively, go to [www.celsielectricfires.co.uk](http://www.celsielectricfires.co.uk) to browse all Celsi electric fires.

