



montrose



inspirational bathroom furniture



manufactured in the uk

e n v i r o n m e n t a l

Increasingly our customers are becoming more concerned with environmental issues and here at montrose furniture we recognise this. We can't simply leave it to others to address this important matter, we must play our own active role in protecting both the local and global environment.

Therefore wherever possible only sustainable & recyclable materials will be used in the manufacture of our products, with raw materials being sourced from other environmentally minded companies, like our timber suppliers who provide us with products from responsibly managed forestry sources worldwide. We are also pleased to advise that Montrose is FSC® Certified (FSC® C142674).



The mark of responsible forestry



For more than 25 years, montrose has been creating beautifully designed, hand built bathroom furniture from its UK manufacturing facility. As you would expect of a specialist bathroom furniture supplier, our dedicated team of employees has formed a product range that will answer even the most challenging design brief. The range of styles, finishes and design combinations we are able to offer, provide the perfect blend for your lifestyle choice and budget.

Whilst the bathroom still remains one of the smaller spaces in many of our homes, this doesn't mean it needs to lack inspiration. We are sure you will find our new collection inspires you to make the right choices for your home.

With our attention to detail, eye for quality and continuous desire for improvement you can be sure montrose will exceed your expectations.

confidence & flexibility



The introduction of the montrose lifetime guarantee is only what customers should expect from a specialist bathroom furniture manufacturer. We are very proud of the high quality products that montrose offers and confident of the longevity they will provide to purchasers. Our aim with montrose lifetime is to give you the same level of confidence when making your brand selection.

www.montrosefurniture.co.uk
for full guarantee details



Whilst the montrose range is extremely comprehensive, there are occasions whereby a special size unit may be required to complete the perfect installation & montrose are able to offer this service, please see our retail price list for more details.

montrose 'a world of choice'

with every piece of montrose furniture the features and benefits come as standard. here are just some to consider



wc and bidet units
with one piece bottom fascia, so there are no awkward gaps



cistern access panel
seamless installations, with easy access



dual flush
simple to operate, with economical water use 3/6 litre flush

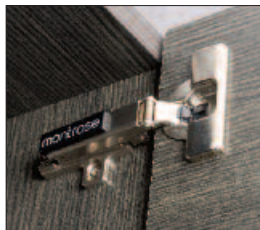

cushion closure
an extra touch of luxury, quiet & smooth, with adjustability



bath access panel
complete that co-ordinated look, provide access in the future



gallery rails
providing greater storage within taller drawers



- FLEXIBLE ranges
- EASY installation
- CHOICE of finishes
- STYLISH looks
- QUALITY build
- COMPETITIVE prices
- LIFETIME guarantee

your bathroom...your bathroom furniture...your montrose

guide to choosing

step 1 size of your bathroom

- master bathroom
- cloakroom

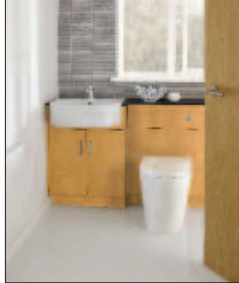

step 2 basic layout

- fitted
- inline - modular
- stand alone
- spacesaver

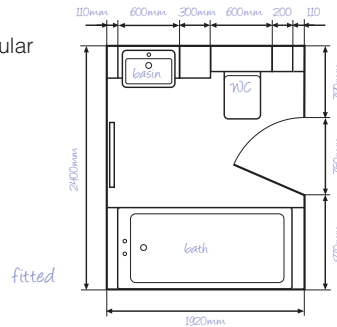

step 3 furniture installation options

- floorstanding
- wall hung 244 or 100mm
- 244mm plinth
- 244mm plinth with longline fronts
- 100mm plinth
- 100mm plinth with longline fronts
- framed



step 4 basins

- sit on
 - gelcast stand alone
 - gelcast inline
 - semi recessed
 - countertop
 - corian / neostone integrated
- See pages 106-113.



step 5 dedicated unit types

- toilet roll holders
 - laundry baskets
 - cutback units
 - bath header units
 - open shelf units
 - curved end units
 - side fillers
 - and many more options...
- See pages 84-90.



step 6 wall space

Storage is at a premium in UK properties, wall units can store lots of your essential items leaving areas clean & tidy. Also using mirrors can increase the perceived space, so consider as part of your overall design, see pages 91 - 93



step 7 door style & finish

One of the fun bits, as this styling will compliment the overall look you want to achieve in the room.

See pages 8-11.



step 8 unit finish

No matter what front finish you have chosen, you are also able to choose from a range of unit finishes to compliment this, at no additional cost.

See page 11.



step 9 handles

31 handle options available, see pages 12-13.



step 10 worktops

- vinyl wrapped & laminate
- neostone solid surface
- dupont corian
- integrated bowls



step 11 LED lighting

Our lighting options, including integrated LED lighting; see pages 94-95.



final step the finished look

Says it all & it's individual to you!



bathroom design & layout

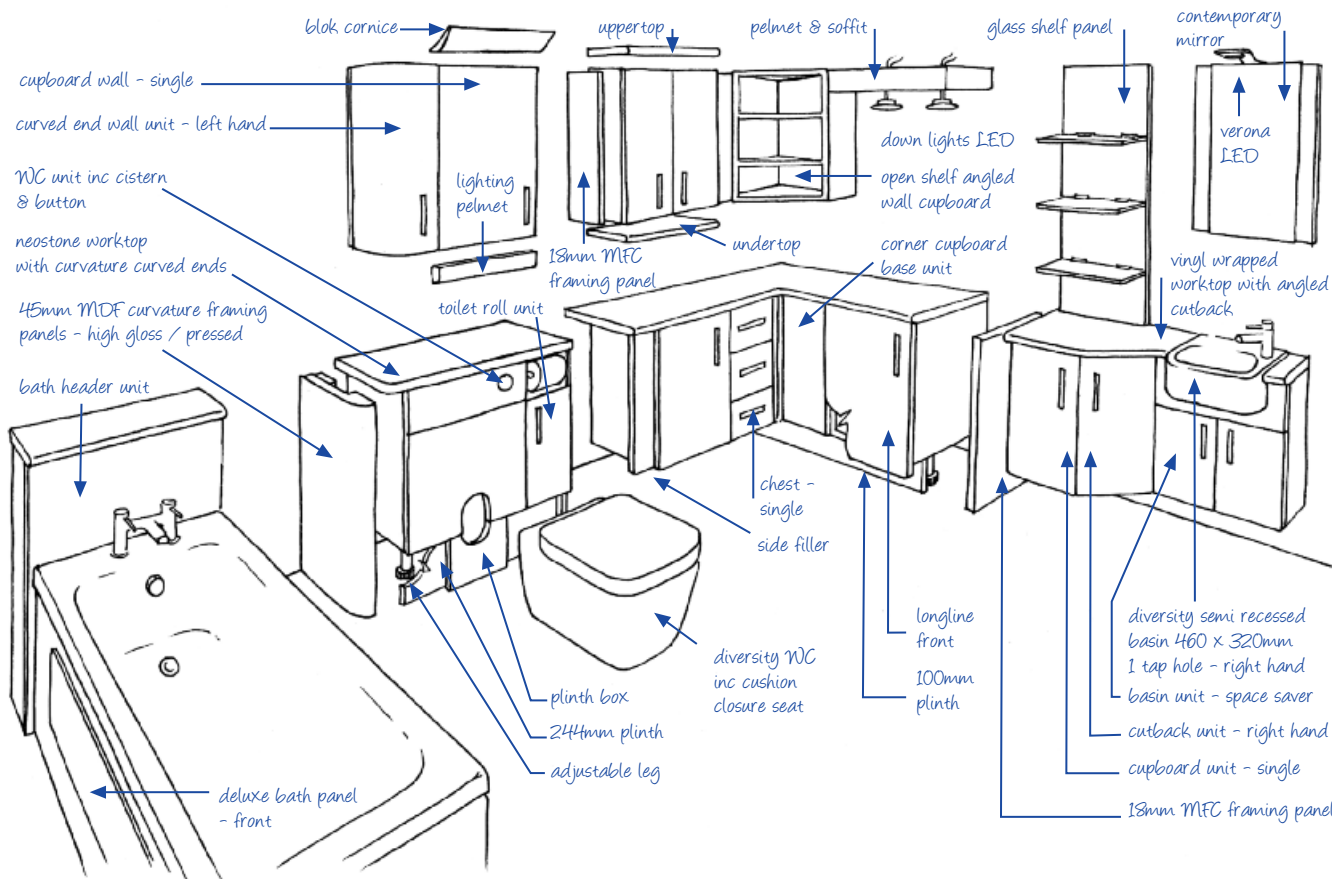

Are you looking for assistance with your bathroom design & layout? Many Montrose dealers can offer either CAD (packages such as Virtual Worlds) or will prepare freehand plans & visualisations. These allow you to get a feel for what the room will look like & importantly, to confirm that dimensions of products selected work in the available space. Some Montrose dealers also operate computer software which can quickly generate quotations for the products selected, make sure to ask your dealer how they can help.

You may find when considering your layout, that you require some specific units, perhaps to fulfil a particular function.

... house a toilet roll holder or perhaps a laundry basket



... to assist with your design layout – a cutback or bath header



Whatever the requirement, even if it's only to fill an awkward space which has been left as part of the overall design – side fillers – Montrose's comprehensive range of unit types will undoubtedly be able to provide the answer.



contents



door styles & finishes	8 - 11
------------------------	--------

door styles	8
longline doors	9
finishes	10 - 11

stand alone gallery	14 - 41
---------------------	---------

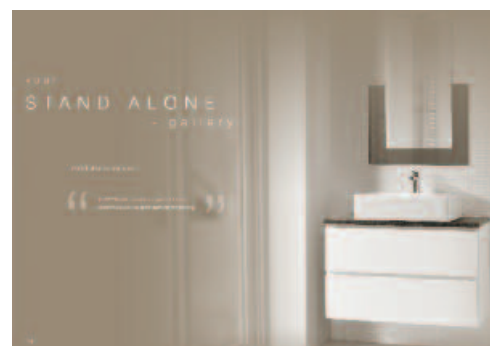

cabinet types	84 - 90
---------------	---------

quick reference guide	84 - 87
unit types & accessories	88 - 90

LED lighting	94 - 95
--------------	---------



worktops	100 - 105
----------	-----------

laminare & vinyl wrapped	100 - 101
neostone	102 - 103
corian solid surface	104 - 105

handles	12 - 13
---------	---------

cushion close & push to open	12
knob handles	12
bar handles	13

in-line / fitted gallery	42 - 83
--------------------------	---------



mirrors	91 - 93
---------	---------

mirrors	91
mirror cabinets	92 - 93

bath panels	96 - 99
-------------	---------

simple	96
standard / standard LED	97
deluxe / deluxe offset	98
storage / storage offset	99

sanitaryware	106 - 113
--------------	-----------

NTX basins & shower trays	106 - 107
gelcast basins	108 - 109
ceramic basins & wcs	110 - 113

door styles

At montrose we manufacture our own doors, so we are able to offer a wide selection to fit our diverse range of units & to keep things simple, these different door styles are all available at the same price *

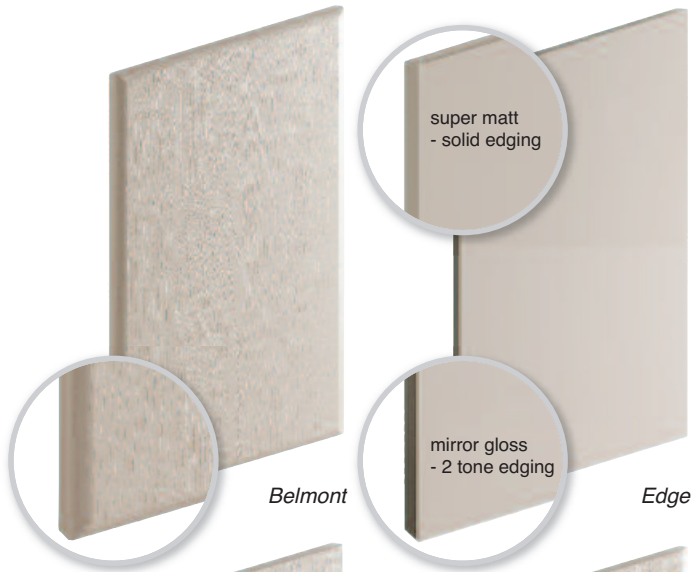

Belmont

Edge



Milan

Nu-Mont



Eton



Heritage



Portland



Suffolk



Bonita
dedicated handle



Orbit
dedicated handle

handles



Handless Milan



Handless Nu-Mont

all above door styles available either push to open or cushion closure

available with cushion closure only

longline fronts

“now
you see
it”

Montrose's longline
fronts option offers you
the opportunity of
extending your units'
doors and drawers,
concealing the plinth

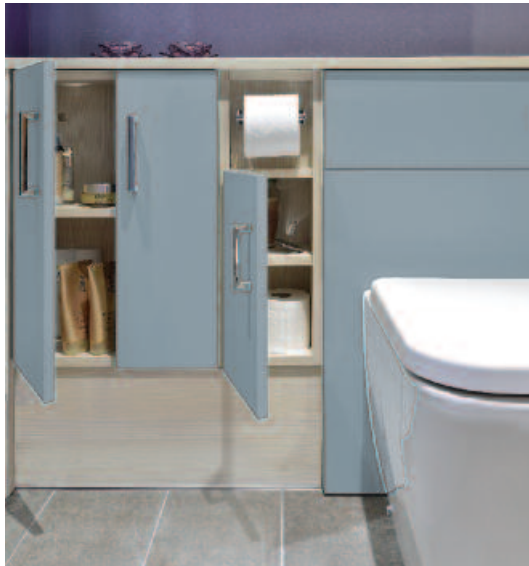

244mm plinth & doors



100mm plinth & doors



244mm plinth & longline doors, 100mm visible plinth



100mm plinth & longline doors, 25mm visible plinth

“now
you
don't”



longline & push to open

door finishes



argento beech *grained* french oak *grained* mali wenge *grained - textured* **NEW** midnight oak natural oak *grained - textured* nordic grey *grained* pippy oak *grained* vintage oak *grained - textured* cashmere elm *grained - textured* mussel elm *grained - textured*



white elm *grained - textured* blue indigo *matt* concrete *matt - textured* denim *matt* dust grey *matt* light grey *matt* parisian blue *matt* stone *matt* soft black *soft* soft ivory *soft*



soft white *soft* anthracite *hi gloss* black *hi gloss* **NEW** cashmere *hi gloss* cream *hi gloss* light grey *hi gloss* white *hi gloss* **NEW** dusty pink *super matt* **NEW** heritage green *super matt* **NEW** maritime blue *super matt*



NEW reed green *super matt* **NEW** smoke *super matt* **NEW** taupe *super matt* **NEW** white grey *super matt* cashmere *mirror gloss* dust grey *mirror gloss* graphite *mirror gloss* light grey *mirror gloss* white *mirror gloss*

GRAIN DIRECTION

A number of door styles offer the option of **VERTICAL (V)** or **HORIZONTAL (H)** grain finish directions.

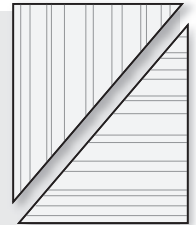

HORIZONTAL (H)



VERTICAL (V)



TRADITIONAL (T)

see matrix page 11

choose your colour **matt or matt grained vinyl**

available door styles as shown in matrix page 11 - finished to match most popular paint finishes



DOOR STYLE / FINISH AVAILABILITY - ALL UNITS

	DOOR STYLE / FINISH AVAILABILITY - ALL UNITS												DANBURY UNITS		
	belmont	bonita	edge	eton	heritage	milan	nu-mont	orbit	portland	suffolk	handless milan	handless nu-mont	heritage	portland	suffolk
GRAINED															
argento beech	✓T	✓H or V	-	✓T	✓T	✓H or V	✓H or V	✓H or V	✓T	✓V	✓H or V	✓H or V	-	-	-
french oak	✓T	✓H or V	-	✓T	✓T	✓H or V	✓H or V	✓H or V	✓T	✓V	✓H or V	✓H or V	-	-	-
mali wenge - textured	✓T	✓H or V	-	-	✓T	✓H or V	✓H or V	✓H or V	-	-	✓H or V	✓H or V	-	-	-
midnight oak	✓T	✓H or V	-	✓T	✓T	✓H or V	✓H or V	✓H or V	✓T	✓V	✓H or V	✓H or V	-	-	-
natural oak - textured	✓T	✓H or V	-	✓T	✓T	✓H or V	✓H or V	✓H or V	✓T	✓V	✓H or V	✓H or V	-	-	-
nordic grey	✓T	✓H or V	-	✓T	✓T	✓H or V	✓H or V	✓H or V	✓T	✓V	✓H or V	✓H or V	✓T	✓T	✓V
pippy oak	✓T	✓H or V	-	✓T	✓T	✓H or V	✓H or V	✓H or V	✓T	✓V	✓H or V	✓H or V	✓T	✓T	✓V
vintage oak - textured	✓T	✓H or V	-	-	✓T	✓H or V	✓H or V	✓H or V	✓T	✓V	✓H or V	✓H or V	✓T	✓T	✓V
cashmere elm - textured	✓T	✓H or V	-	✓T	✓T	✓H or V	✓H or V	✓H or V	✓T	✓V	✓H or V	✓H or V	✓T	✓T	✓V
mussel elm - textured	✓T	✓H or V	-	✓T	✓T	✓H or V	✓H or V	✓H or V	✓T	✓V	✓H or V	✓H or V	✓T	✓T	✓V
white elm - textured	✓T	✓H or V	-	✓T	✓T	✓H or V	✓H or V	✓H or V	✓T	✓V	✓H or V	✓H or V	✓T	✓T	✓V
MATT & SOFT															
blue indigo - matt	✓	✓	-	✓	✓	✓	✓	✓	✓	✓	✓	✓	✓	✓	✓
concrete - matt	✓	✓	-	-	-	✓	✓	✓	-	-	✓	✓	-	-	-
denim - matt	✓	✓	-	✓	✓	✓	✓	✓	✓	✓	✓	✓	✓	✓	✓
dust grey - matt	✓	✓	-	✓	✓	✓	✓	✓	✓	✓	✓	✓	✓	✓	✓
light grey - matt	✓	✓	-	✓	✓	✓	✓	✓	✓	✓	✓	✓	✓	✓	✓
parisian blue - matt	✓	✓	-	✓	✓	✓	✓	✓	✓	✓	✓	✓	✓	✓	✓
stone - matt	✓	✓	-	✓	✓	✓	✓	✓	✓	✓	✓	✓	✓	✓	✓
soft black - soft	✓	✓	-	✓	✓	✓	✓	✓	✓	✓	✓	✓	✓	✓	✓
soft ivory - soft	✓	✓	-	✓	✓	✓	✓	✓	✓	✓	✓	✓	✓	✓	✓
soft white - soft	✓	✓	-	✓	✓	✓	✓	✓	✓	✓	✓	✓	✓	✓	✓
HI GLOSS															
anthracite	✓	✓	-	-	-	✓	✓	✓	-	✓	✓	✓	-	-	-
black	✓	✓	-	-	-	✓	✓	✓	-	✓	✓	✓	-	-	-
cashmere	✓	✓	-	-	-	✓	✓	✓	-	✓	✓	✓	-	-	-
cream	✓	✓	-	-	-	✓	✓	✓	-	✓	✓	✓	-	-	-
light grey	✓	✓	-	-	-	✓	✓	✓	-	✓	✓	✓	-	-	-
white	✓	✓	-	✓	-	✓	✓	✓	-	✓	✓	✓	-	-	-
SUPER MATT & MIRROR GLOSS															
dusty pink - matt	-	-	✓	-	-	-	-	-	-	-	-	-	-	-	-
heritage green - matt	-	-	✓	-	-	-	-	-	-	-	-	-	-	-	-
maritime blue - matt	-	-	✓	-	-	-	-	-	-	-	-	-	-	-	-
reed green - matt	-	-	✓	-	-	-	-	-	-	-	-	-	-	-	-
smoke - matt	-	-	✓	-	-	-	-	-	-	-	-	-	-	-	-
taupe - matt	-	-	✓	-	-	-	-	-	-	-	-	-	-	-	-
white grey - matt	-	-	✓	-	-	-	-	-	-	-	-	-	-	-	-
cashmere - gloss	-	-	✓	-	-	-	-	-	-	-	-	-	-	-	-
dust grey - gloss	-	-	✓	-	-	-	-	-	-	-	-	-	-	-	-
graphite - gloss	-	-	✓	-	-	-	-	-	-	-	-	-	-	-	-
light grey - gloss	-	-	✓	-	-	-	-	-	-	-	-	-	-	-	-
white - gloss	-	-	✓	-	-	-	-	-	-	-	-	-	-	-	-
PAINTED															
colour match	✓	✓	-	✓	✓	✓	✓	✓	✓	✓	✓	✓	✓	✓	✓

CARCASE FINISHES mix & match

once you have chosen your door style and finish you can choose from any of the following unit finishes*



* units are only available in matt finishes but can be ordered with replacement ends – pressed / hi gloss at additional cost

handle options

door & drawer opening & closure options

Traditionally Montrose door & drawer systems have always been pull to open & cushion closure, now customers also have the choice of a Push to Open system, suitable for most Montrose door styles. The Push to Open system allows for the surface of your fronts to be totally uninterrupted & is available at additional cost.

Pull to Open, cushion closure doors & drawers



Push to Open, doors & drawers without handles

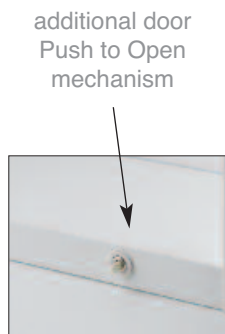
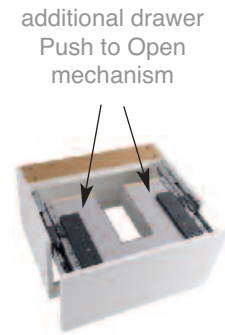

H6/B
brass



H6/C
chrome



H7B/N
black



H7C/N
chrome



H8
ivory



H8
white



H36/N
shiny black nickel



H43
mirror cabinet handle
chrome



H44
chrome



H51
chrome



H56
chrome



H61
chrome



H63/N
chrome



H71
brushed nickel



H77/N
matt brass

handle options



H2
chrome
vertical



H17/N*
chrome
vertical / horizontal - 4 sizes

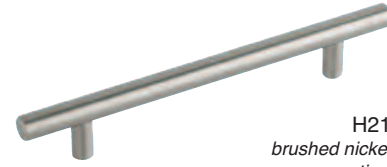

H21
brushed nickel
vertical



H23
chrome
vertical



H39*
chrome
vertical / horizontal - 5 sizes



H40*
chrome
vertical - 2 sizes



H41
chrome
vertical



H45/N
black
vertical



H52
chrome
horizontal offset



H54/N
brushed nickel
vertical



H76/SS
stainless steel



H78*
brushed nickel
vertical / horizontal - 5 sizes - for modular units only



H79*
chrome
horizontal - 4 sizes - for modular units only

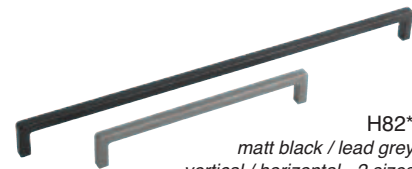

H82*
matt black / lead grey
vertical / horizontal - 2 sizes

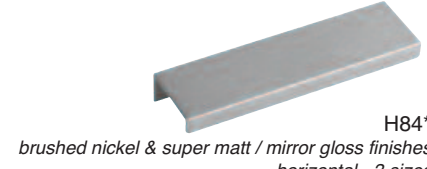

H84*
brushed nickel & super matt / mirror gloss finishes
horizontal - 3 sizes



H85
black
horizontal - 2 sizes



H84 handle

* multiple sizes available, suitability dependent on specific use, please see retail price list

your

STAND ALONE

- gallery

[modular furniture]

“

STAND ALONE - meaning a single unit, which is attached to a rear wall but is otherwise free standing

”







hi-line double basin unit types available:

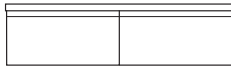

1 drawer - compact

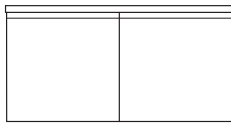

1 drawer - high

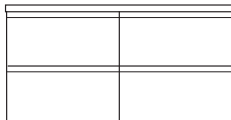

2 drawer

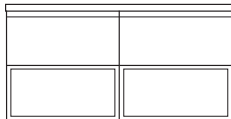

1 drawer & open shelf

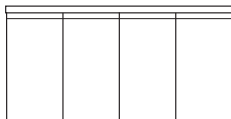

2 door - high

available 100mm / 244mm
plinth or wall hung

gelcast basin sizes available:

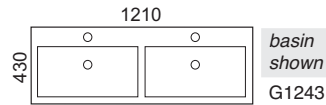

other basin options - corian /
neostone worktop & integrated bowl:

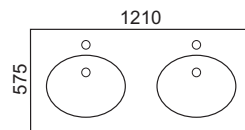
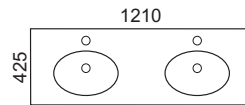

available 1210 - 1610mm widths

type
shown
DUO12S

hi-line single basin unit types available:

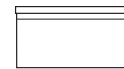

1 drawer
- compact



1 drawer - high

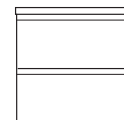

2 drawer

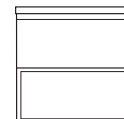

1 drawer & open shelf

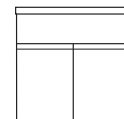

2 door

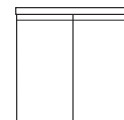

2 door - high

available 100mm / 244mm
plinth or wall hung

gelcast basin sizes available:

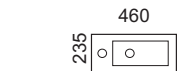
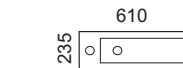
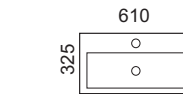
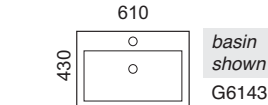
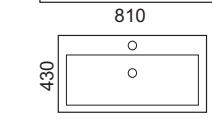
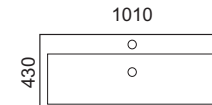

other basin options -
corian / neostone worktop
& integrated bowl:

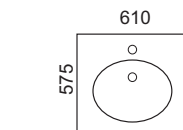
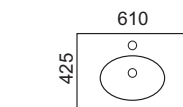

shown with



door
concrete



carcase
dust grey



door style
handless milan



hi-line stand alone basin unit with single basin

full dimension details available from dealer or retail price guide

handless
milan door
finishes
page 10



26

door
styles
page 8



11

worktop
finishes
pages
100-105

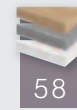

58

carcase
finishes
page 11

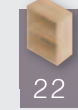

22

handle
options
pages
12-13

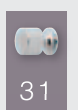

31



lo-line single basin unit types available:

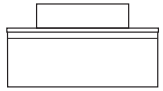

1 drawer - compact

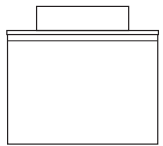

1 drawer - high



1 drawer & open shelf

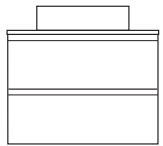

2 drawer

type shown
DUL80S

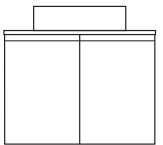

2 door

available 100mm / 244mm
plinth or wall hung

ceramic basins available
- requires worktop:

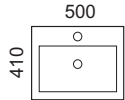

basin shown
SO50B

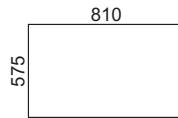
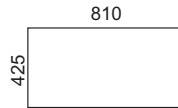

available 610 - 910mm widths

lo-line double basin unit types available:

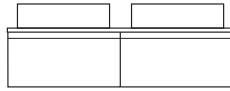

2 drawer - compact

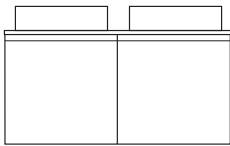

2 drawer - high

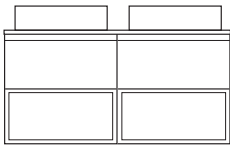

2 drawer & 2 open shelves

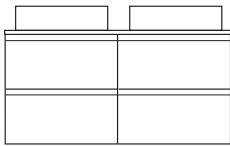

4 drawer

type shown
DDUL12S

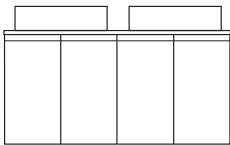

4 door

ceramic basins available
- requires worktop:

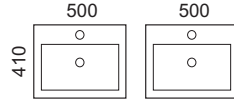

basin shown
SO50B (x2)

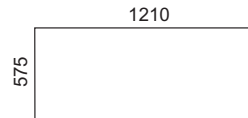
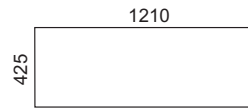
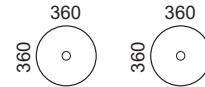

available 1210 - 1610mm widths

shown with



door
hi gloss white



carcase
soft white



worktop
12mm lava neostone



door style
handless milan



lo-line stand alone basin unit with double basin

full dimension details available from dealer or retail price guide

handless
milan door
finishes
page 10

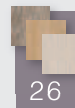

26

door
styles
page 8



11

worktop
finishes
pages
100-105



58

carcase
finishes
page 11

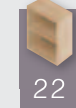

22

handle
options
pages
12-13

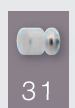

31

incline

stand alone basin unit

shown with

 **door**
hi gloss black

 **carcase**
pippy oak

 **handle**
H39

 **door style**
milan

Incline basin unit
types available:

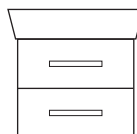
 **type shown**
IBDDU55
includes basin

2 drawer

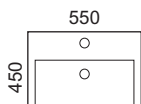
 **basin shown**
incline

550
450



incline - doorline - double door unit & ceramic basin

available 100mm / 244mm
plinth or wall hung

full dimension details available from dealer or retail price guide

 milan door finishes
page 10

26

 door styles
page 8

11

 carcass finishes
page 11

22

 handle options
pages 12-13

30



indigo

stand alone basin unit

shown with



door

light grey



carcase

light grey



door style

handless
indigo wave

Indigo basin unit types available:

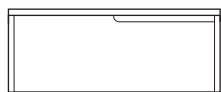

1 drawer

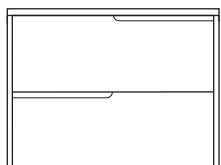

2 drawer

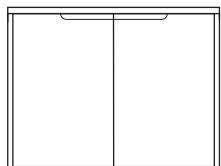

2 door

available 100mm / 244mm
plinth or wall hung

type shown
INDDP10
includes
basin

Indigo ceramic basin /
unit sizes available:

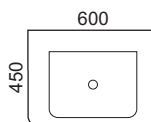

600

450

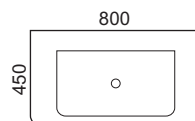

800

450

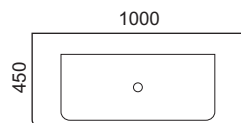

1000

450

basin shown

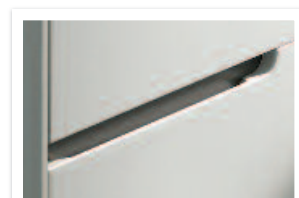

handless indigo wave door
style - exclusive to indigo
basin unit - finishes as
handless milan & nu-mont

full dimension details available
from dealer or retail price guide



milan
door
finishes
page 10



door
styles
page 8



carcase
finishes
page 11

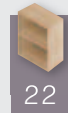

handle
options
pages
12-13



your choices - to room contents shown

indigo

stand alone basin unit - floorstanding

shown with



door
stone



carcase
stone



door style
handless
indigo wave

Indigo basin unit types available:

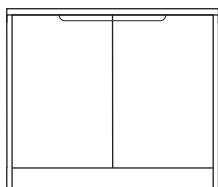

2 door

type shown
INF DORP10
includes basin & plinth

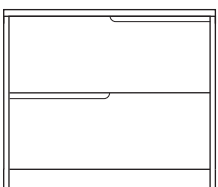

2 drawer

available 100mm plinth

Indigo ceramic basin / unit sizes available:

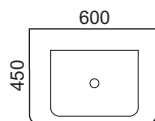

600

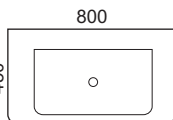

800

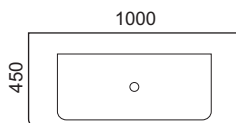

1000

basin shown



Indigo double drawer basin unit

full dimension details available from dealer or retail price guide



indigo wave door finishes
page 10

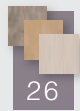

26

door styles
page 8



2

carcase finishes
page 11

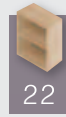

22

handle options
pages 12-13



32

matteo

stand alone basin units

shown with



door
denim



carcase
denim



handle
H76/SS

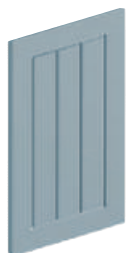

door style
suffolk

Matteo basin unit types available:

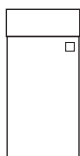

type shown
MAT34 (L/R)
includes basin

1 door

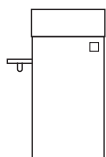

1 door
includes soap / toilet roll shelf

available wall hung

Matteo ceramic basin / unit sizes available:



basin shown



toilet roll holder & soap stand available

full dimension details available from dealer or retail price guide

indigo wave door finishes
page 10

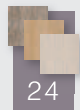

door styles
page 8



carcase finishes
page 11

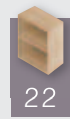

handle options
pages 12-13



your choices - to room contents shown



ntx

natural texture - stand alone basin unit

shown with

door
super matt dusty pink

carcase
midnight oak

handle
H84 - brushed nickel



door style edge

ntx basin unit types available:

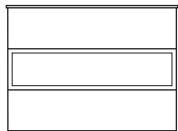

1 drawer

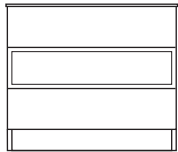

1 drawer & tf panels

available 100mm / 244mm plinth or wall hung

for other ntx options see pages 106-107

full dimension details available from dealer or retail price guide

ntx basin / unit sizes available:

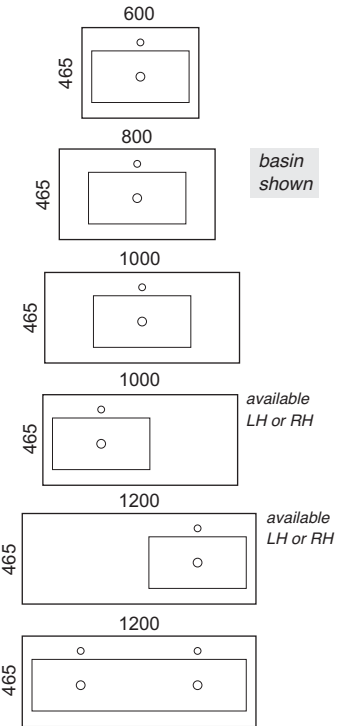

basin shown

available LH or RH

available LH or RH



edge door finishes page 10



door styles page 8



worktop finishes pages 100-105



carcase finishes page 11

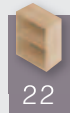

handle options pages 12-13



recess

stand alone basin units

shown with

 **door & carcass**
hi gloss anthracite

 **worktop**
hi gloss white

 **handle**
H56

 **door style**
milan

recess basin unit
types available:

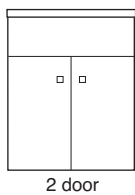
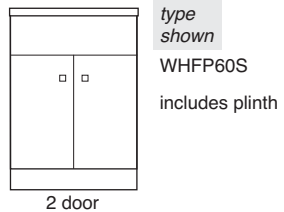

available 100mm / 244mm
plinth or wall hung

ceramic basin sizes available
- requires worktop:

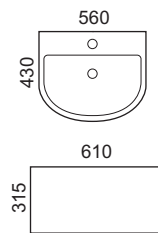
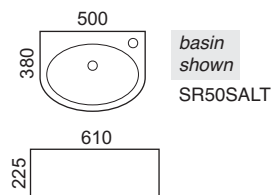

available 610 - 910mm widths

for other semi recessed basin
options see pages 111-113

full dimension details available from dealer or retail price guide

milan
door
finishes
page 10



door
styles
page 8



worktop
finishes
pages
100-105



carcase
finishes
page 11



handle
options
pages
12-13



stadium 2

stand alone basin unit

shown with



Stadium 2 basin unit types available:

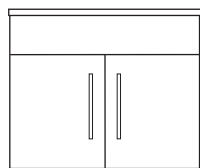

2 door

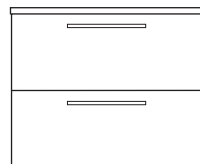

2 drawer

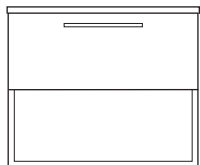

1 drawer & open shelf

type shown
ST2DUP60
includes basin

Stadium 2 ceramic basin / unit sizes available:

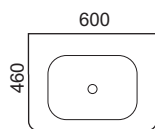
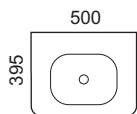

basin shown

available 100mm / 244mm plinth or wall hung

full dimension details available from dealer or retail price guide



milan
door
finishes
page 10

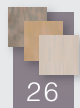

door
styles
page 8



carcase
finishes
page 11



handle
options
pages
12-13



storage stool

stand alone basin units

shown with



door & carcase
mali wenge



worktop
mali wenge vinyl wrapped



door style
milan

vertical grain
also available
- see page 10



handle
H39

storage stool basin
unit types available:

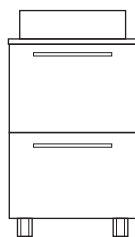

1 drawer &
storage stool

type shown

SSDUH60S
& SSU60S

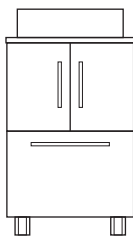

2 door &
storage stool

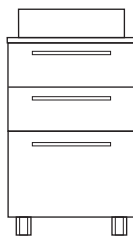

2 drawer &
storage stool

ceramic basin sizes
available - requires worktop:

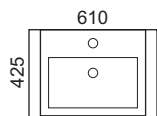

basin
shown
SO50B

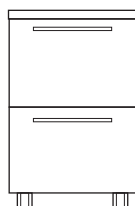
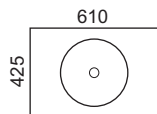

1 drawer &
storage stool

gelcast basin
sizes available:

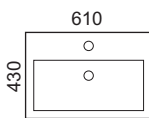

610 storage stool basin
unit floorstanding

available wall hung

full dimension details available from dealer or retail price guide

milan
door
finishes
page 10

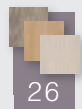

door
styles
page 8



worktop
finishes
pages
100-105



carcase
finishes
page 11

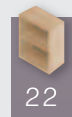

handle
options
pages
12-13



your choices - to room contents shown



uni

stand alone basin unit - framed

shown with

 **door**
light grey

 **carcase**
dust grey



door style
handless milan

Uni basin unit types available:

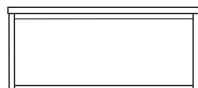

1 drawer

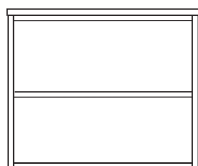

2 drawer

available wall hung

type shown
UNIDDP80
includes basin

Uni ceramic basin / unit sizes available:

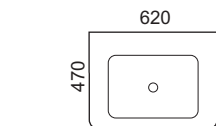

620

470

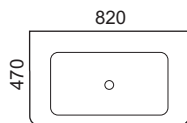

820

470

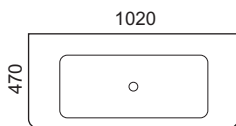

1020

470

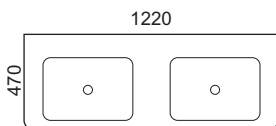

1220

470

basin shown

full dimension details available from dealer or retail price guide

handless milan door finishes
page 10

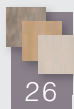

26

door styles
page 8



2

carcase finishes
page 11



22

handle options
pages 12-13



31



curve

stand alone basin units

shown with

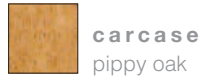

curved basin unit types available:

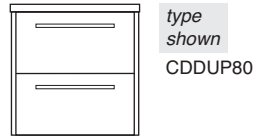

2 drawer

available wall hung

gelcast basin sizes available:

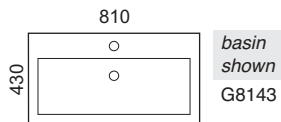
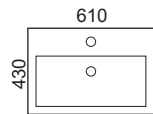

full dimension details available from dealer or retail price guide

milan door finishes
page 10

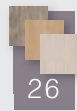

carcase finishes
page 11



handle options
pages 12-13



your choices - to room contents shown



angled

stand alone basin / wc units

shown with



angled wc unit
types available:

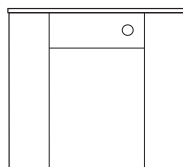

type shown
ADVF

floorstanding

angled WC worktop
sizes available:

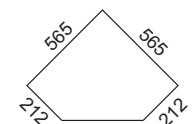
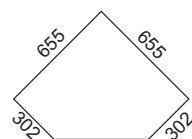

full dimension details available from dealer or retail price guide

angled basin unit
types available:

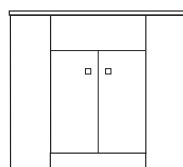

type shown
AVUP

plinth
PLP12PR

available 100mm / 244mm plinth or wall hung

ceramic basins available
- requires worktop:

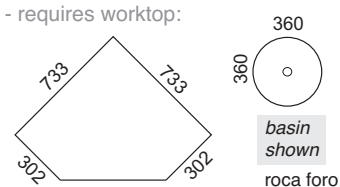

angled worktop sizes available
- corian / neostone integrated bowl:

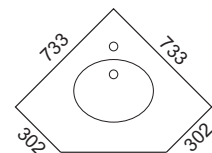

milan door finishes
page 10

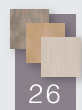

door styles
page 8



worktop finishes
pages 100-105



carcase finishes
page 11

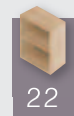

handle options
pages 12-13



corner curved

stand alone basin units

shown with



door & carcass
nordic grey



door style
curved milan



worktop
12mm crystal neostone

horizontal grain
also available
- see page 10



handle
H40

curved corner basin /
wc unit types available:

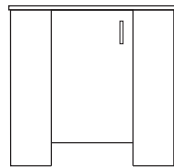

type shown
CACP



plinth

1 door PLPCC60F

available 100mm / 244mm
plinth or wall hung

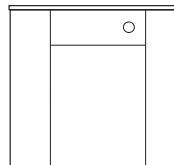

type shown
ADVF

floorstanding

345

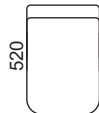

wc shown

BTWC2COMP

full dimension details available from dealer or retail price guide

ceramic basins available
- requires worktop:

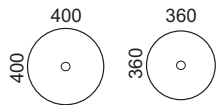

400

360

basin shown

roca foro

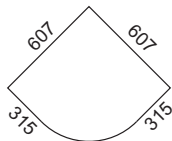

607

607

315

315

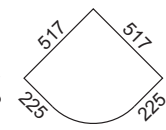

517

517

225

225

other basin options -
corian / neostone worktop
& integrated bowl:

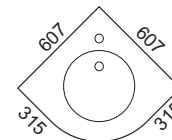

607

607

315

315

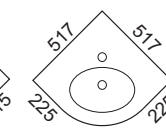

517

517

225

225

curved
milan door
finishes
page 10



26

worktop
finishes
pages
100-105



58

carcase
finishes
page 11



22

handle
options
pages
12-13

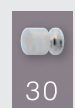

30

your choices - to room contents shown



D-line

stand alone basin units

shown with



door & carcass
mali wenge



worktop
12mm crystal neostone



handle
H17/N



door style
curved milan

horizontal grain
also available
- see page 10

d-line basin unit
types available:

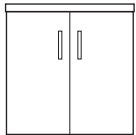

2 door

type shown
WHCDP60

available 100mm / 244mm
plinth or wall hung

gelcast basin
sizes available:

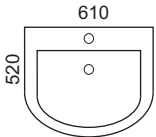

520

610

basin shown
GD6152

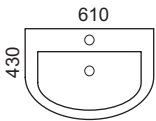

430

610

other basin options - corian /
neostone worktop & integrated bowl:

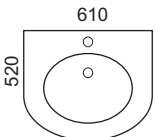

520

610

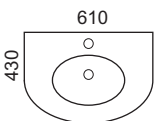

430

610

full dimension details available from dealer or retail price guide



curved
milan door
finishes
page 10



26

worktop
finishes
pages
100-105



58

carcase
finishes
page 11



22

handle
options
pages
12-13



30

S-line

stand alone basin units

shown with

door
hi gloss anthracite

carcase
argento beech

handle
H56

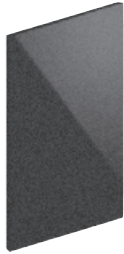

door style
curved milan

s-line basin unit
types available:

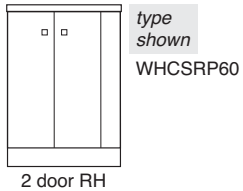

2 door RH

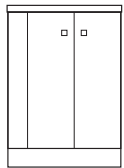

2 door LH

available 100mm / 244mm
plinth or wall hung

gelcast basin
sizes available:

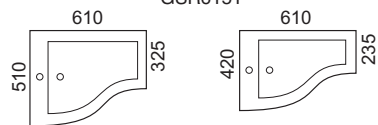
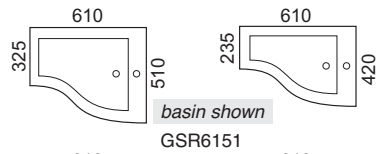

other basin options - corian /
neostone worktop & integrated bowl:

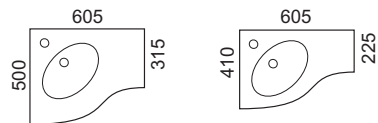
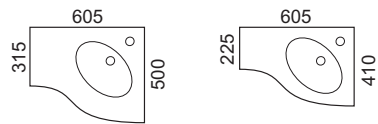

full dimension details available from dealer or retail price guide



curved
milan door
finishes
page 10

worktop
finishes
pages
100-105

carcase
finishes
page 11

handle
options
pages
12-13

26

58

22

30

your choices - to room contents shown

V-line

stand alone basin units - pto

shown with



door
hi gloss white



carcase
soft white



worktop
hi gloss white laminate



door style
milan

v-line basin unit types available:

gelcast basin sizes available - requires worktop:

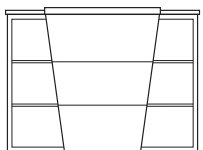

2 drawer & 2 open shelves

type shown
V VP10PTO

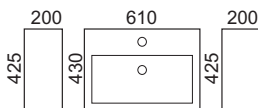
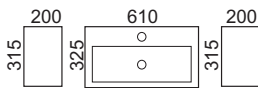

basin shown
G6143

other basin options - corian / neostone worktop & integrated bowl:

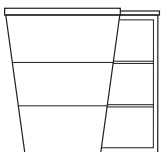
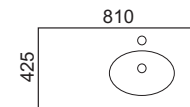
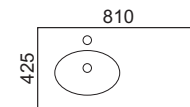
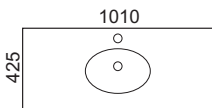

2 drawer & open shelf RH
- LH version also available

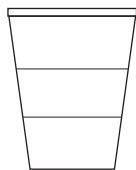

2 drawer

available wall hung

full dimension details available from dealer or retail price guide



v-line basin unit - 2 drawer



v-line basin unit - 2 drawer & open shelf RH



milan door finishes
page 10

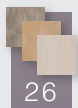

worktop finishes
pages 100-105



carcase finishes
page 11



full height

stand alone wc unit

shown with

door
hi gloss anthracite

carcase
anthracite matt

handle
H78

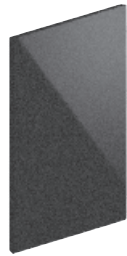

door style
milan

full height wc unit types available:

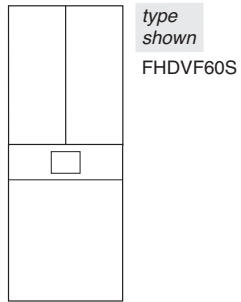

type shown
FHDVF60S

floorstanding wall hung WC's

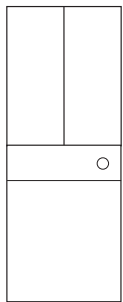

floorstanding BTW WC's
available 600 - 900mm widths

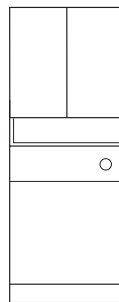

full height floorstanding WC unit with open shelf

wall hung wc suite sizes available:

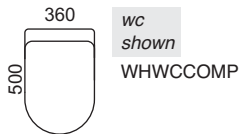

wc shown
WHWCCOMP

back to wall wc suite sizes available:

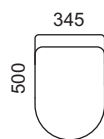

for other wall hung or BTW WC options see pages 112-113

full dimension details available from dealer or retail price guide



milan door finishes
page 10

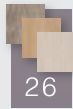

door styles
page 8



worktop finishes
pages 100-105



carcase finishes
page 11



handle options
pages 12-13

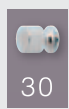

your choices - to room contents shown

danbury

hi-line basin unit

shown with



door & carcass
light grey



worktop & upstand
12mm calacatta
neostone



door style
danbury - suffolk



handle
H76/SS

danbury basin unit
types available:

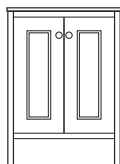

type shown

DBVH60

2 door

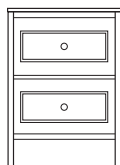

2 drawer

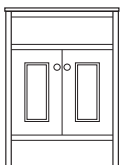

2 door

floorstanding

full dimension details available
from dealer or retail price guide

neostone basin / worktop
sizes available:

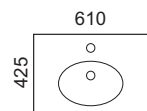

610

425

bowl shown

WTNLDBOV61S

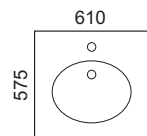

610

575

available 610 - 710mm widths

danbury plinth options

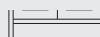

freestanding



traditional



scalloped



danbury
suffolk door
finishes
page 10



14

door
styles
page 8



2

worktop
finishes
pages
100-105



24

carcase
finishes
page 11



14

handle
options
pages
12-13



30

danbury

lo-line basin unit

shown with



door
dust grey



carcase
light grey



worktop
12mm calacatta
neostone



door style
danbury - heritage



handle
H76/SS

danbury basin unit
types available:

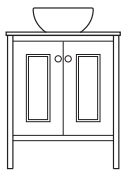

2 door

type shown
DBVL60



2 drawer

floorstanding

ceramic basins available
- requires worktop:

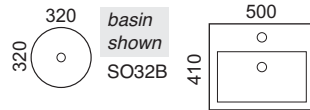

basin shown
SO32B

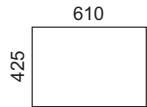
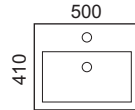

worktop shown

WTNLDB61S

available 610 - 710mm widths

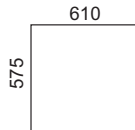

danbury plinth options



freestanding

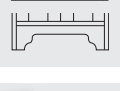

traditional

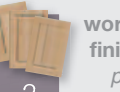

scalloped



danbury
heritage
door finishes
page 10

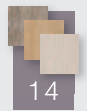

door
styles
page 8



worktop
finishes
pages
100-105

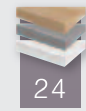

carcase
finishes
page 11



handle
options
pages
12-13



your choices - to room contents shown

danbury

hi-line basin unit

shown with



door
light grey



carcase
dust grey



worktop & upstand
12mm calacatta neostone



door style
danbury - portland



handle
H45/N

danbury basin unit types available:

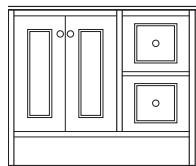

2 door & 2 drawer LH

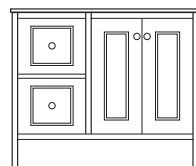

2 door & 2 drawer RH

floorstanding

type shown
DBSDLVH10

neostone basin / worktop sizes available:

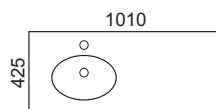

bowl shown

WTNLDBOVL101S

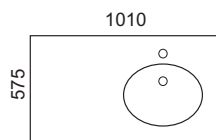
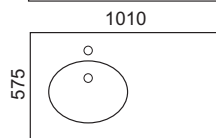
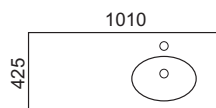

available
1010 -
1110mm
widths

full dimension details available
from dealer or retail price guide

danbury plinth options

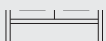

freestanding

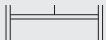

traditional



scalloped



danbury
portland door
finishes
page 10



door
styles
page 8



worktop
finishes
pages
100-105



carcase
finishes
page 11



handle
options
pages
12-13

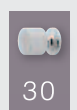

danbury

lo-line basin unit

shown with

 **door & carcass**
dust grey

 **worktop & upstand**
12mm calacatta neostone

 **handle**
H45/N



door style
danbury - portland

danbury basin unit types available:

ceramic basins available - requires worktop:

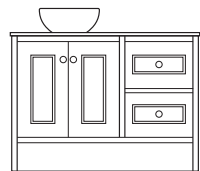

type shown
DBSDLVL10

2 door & 2 drawer LH

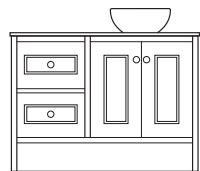

2 door & 2 drawer RH

floorstanding

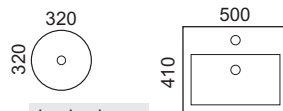

basin shown
SO32B

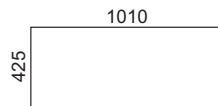

worktop shown
WTNLDB101S

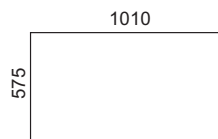

available 1010 - 1110mm widths

danbury plinth options



freestanding

traditional

scalloped

full dimension details available from dealer or retail price guide



danbury portland door finishes page 10



door styles page 8



worktop finishes pages 100-105



carcase finishes page 11



handle options pages 12-13



30

your choices - to room contents shown

danbury

hi-line basin unit

shown with



door & carcass
denim



worktop & upstand
12mm calacatta
neostone



handle
H76/SS



door style
danbury - suffolk

danbury basin unit
types available:

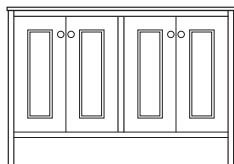

4 door

type shown
DBDVH12

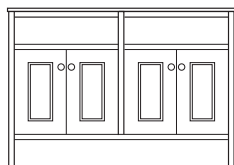

4 door

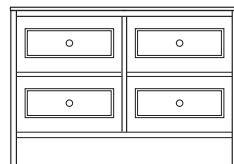

4 drawer

floorstanding

full dimension details available
from dealer or retail price guide

neostone basin / worktop
sizes available:

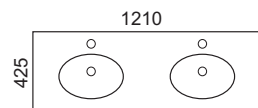

1210

bowl shown
WTNLDB121S

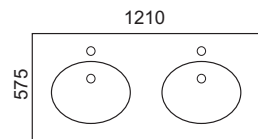

1210

available 1210 - 1410mm widths

danbury plinth options

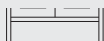

freestanding

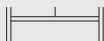

traditional



scalloped



danbury
suffolk door
finishes
page 10



door
styles
page 8



worktop
finishes
pages
100-105



carcase
finishes
page 11

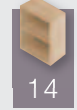

handle
options
pages
12-13

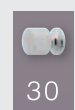

danbury

lo-line basin unit

shown with

door & carcass
denim

worktop & upstand
12mm calacatta neostone

handle
H76/SS



door style
danbury - suffolk

danbury basin unit types available:

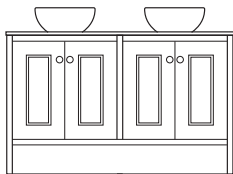

4 door

type shown

DBDVL12



4 drawer

floorstanding

danbury plinth options



freestanding

traditional

scalloped

ceramic basins available - requires worktop:

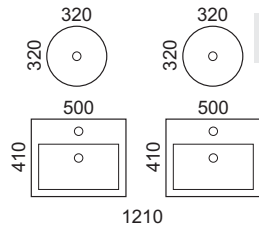

basins shown
SO32B



worktop shown

WTNLDB121S

1210



available 1210 - 1410mm widths

full dimension details available from dealer or retail price guide



danbury floorstanding wc unit



danbury suffolk door finishes page 10



14

door styles page 8



2

worktop finishes pages 100-105

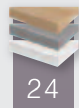

24

carcase finishes page 11



14

handle options pages 12-13

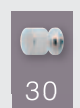

30

your choices - to room contents shown

your

IN-LINE & FITTED - gallery

[inline furniture]

“

IN-LINE - meaning multiple units which combine to create the impression of a larger modular unit, they are attached to one another & a rear wall but are free standing of adjacent walls

”

[fitted furniture]

“

FITTED - meaning multiple units, which are attached to one another, a rear wall & adjacent walls, spanning the space in between

”









linen glazed tall wall cupboard

FEATURE FOCUS

linen glazed units - provide you with great additional storage, a degree of visibility in relation to the items within them but also add some variation to visible doors, which is a pleasing feature when a higher number of units are being incorporated.

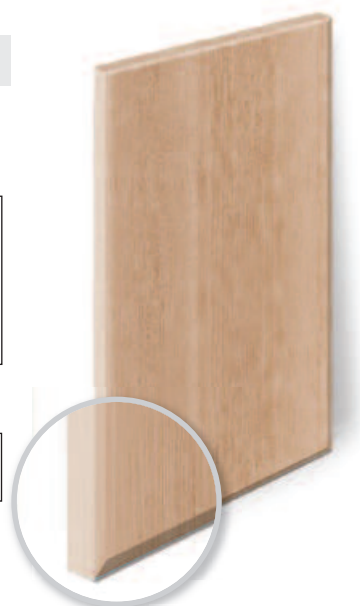
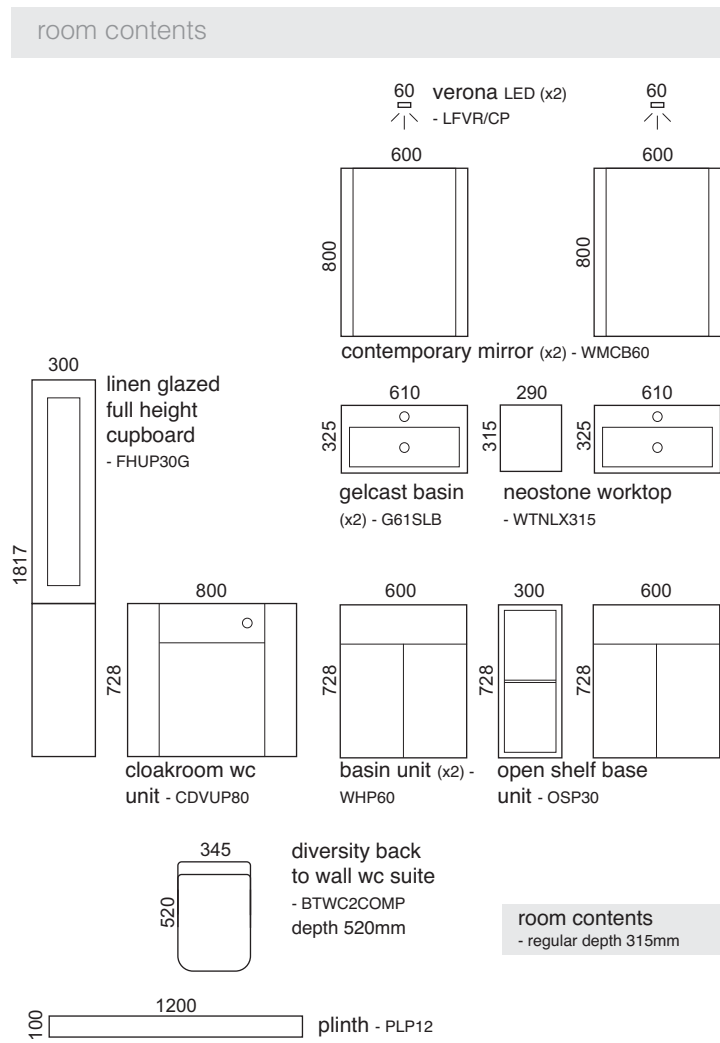

handle
H40

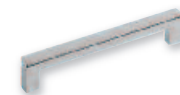

worktop

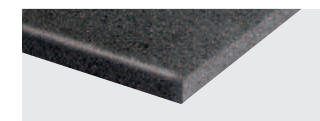

12mm lava neostone

door



natural oak

carcase



natural oak

room contents
- regular depth 315mm

units available 100mm / 244mm plinth or wall hung

belmont
door
finishes
page 10

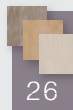

door
styles
page 8



worktop
finishes
pages
100-105

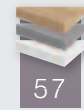

carcase
finishes
page 11

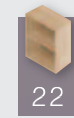

handle
options
pages
12-13







cut back

FEATURE FOCUS

cut backs - provide a pleasing design feature, whilst also proving practical where space is more limited. For instance when Back to Wall WC's are being fitted cutting back to say Spacesaver depth reduces the overall projection & provides easier access.

room contents

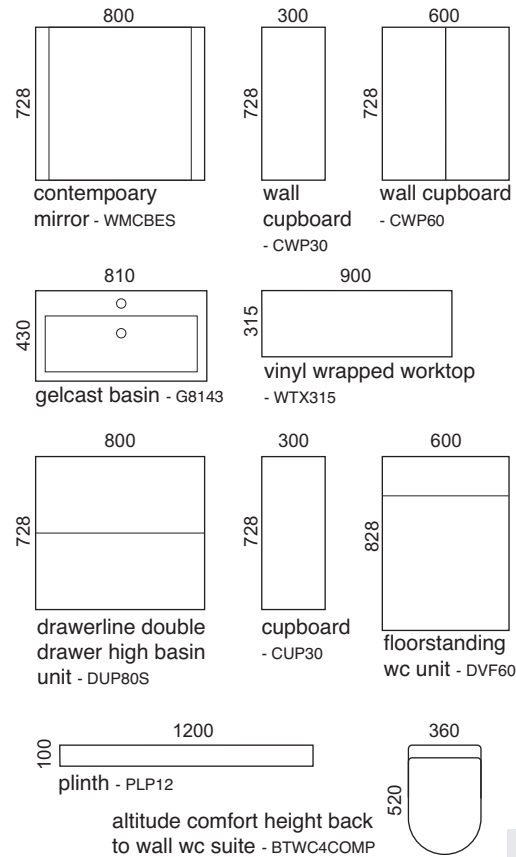

handle
H80
exclusive to Bonita



worktop



hi gloss light grey vinyl wrapped

door

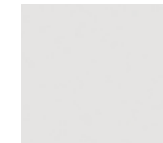

hi gloss
light grey

carcase

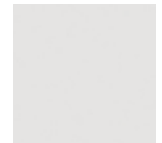

matt light
grey

room contents
- full depth 425mm
- regular depth 315mm
- slimline depth 130mm

units available 100mm / 244mm plinth or wall hung

bonita door
finishes
page 10

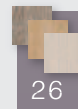

26

door
styles
page 8



11

worktop
finishes
pages
100-105

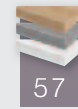

57

carcase
finishes
page 11



22

handle
options
pages
12-13

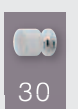

30

your choices - to room contents shown



edge door style finish options



the edge door style and edging detail - in super matt finishes, give the look of solid finish fronts with 7 great colours to choose from. The clean crisp finish achieved, provide cutting edge style & a distinctive impact for your furniture.

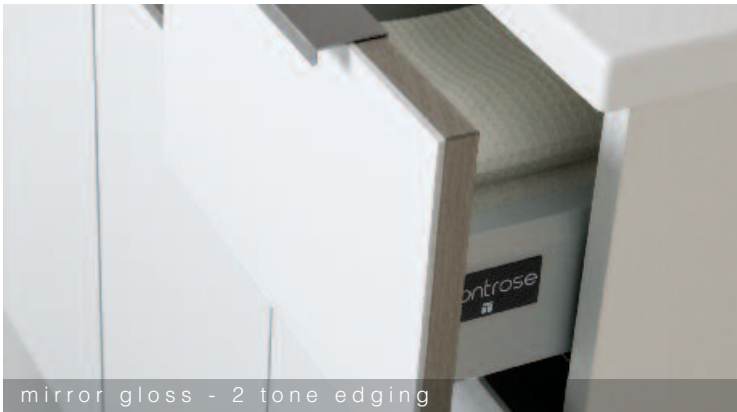

the edge door style and edging detail - in mirror gloss finishes, give the look of applied glass fronts with 5 mirror gloss colours to choose from. The clean precise lines achieved, provide cutting edge style & a distinctive impact for your furniture.

room contents

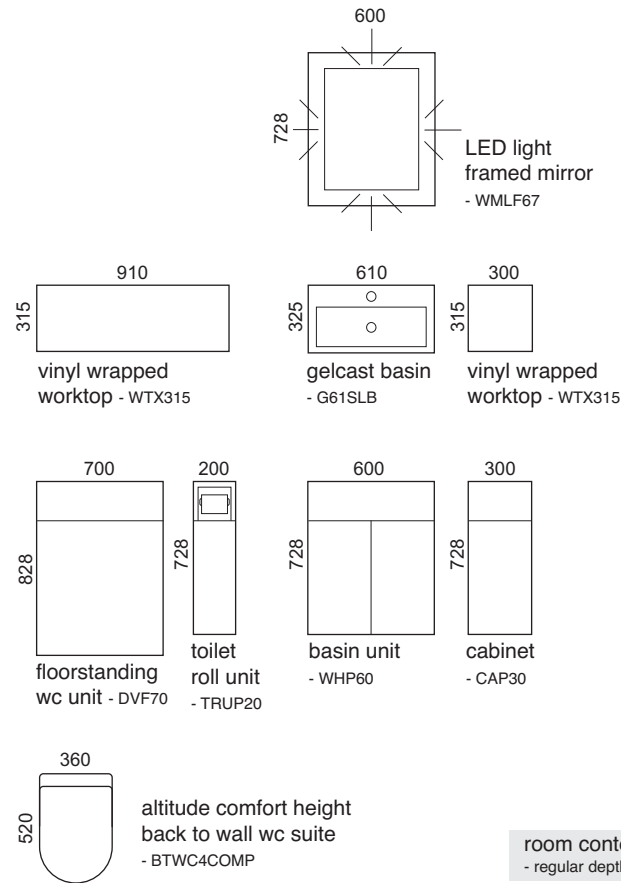

room contents
- regular depth 315mm

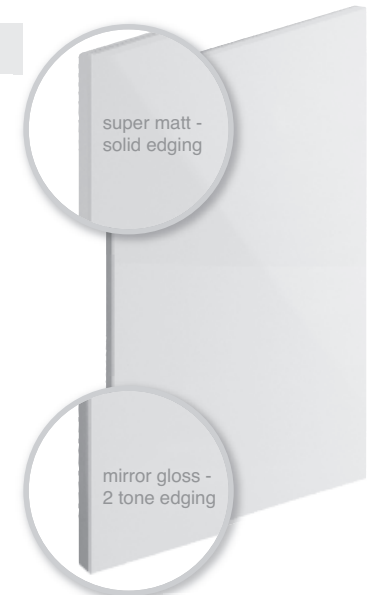

hi gloss white vinyl wrapped

door



mirror gloss white

carcase

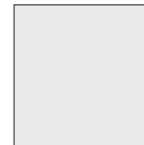

soft white

units available 100mm / 244mm plinth or wall hung

edge door finishes page 10	11	door styles page 8	11	worktop finishes pages 100-105	57	carcase finishes page 11	22	handle options pages 12-13	30
-------------------------------	----	-----------------------	----	-----------------------------------	----	-----------------------------	----	-------------------------------	----





toilet roll unit



framing panels

FEATURE FOCUS

toilet roll units - provide a dedicated location for this essential of items, whilst also giving additional storage for other bathroom products.

framing panels - make the doors & drawers of your Montrose bathroom furniture seem flush to the carcass, they also provide an opportunity to create a great contrasting look, when a different finish framing is used to the fronts finish. With a number of options, including curved & traditional, framing panels offer truly individual styling.

room contents

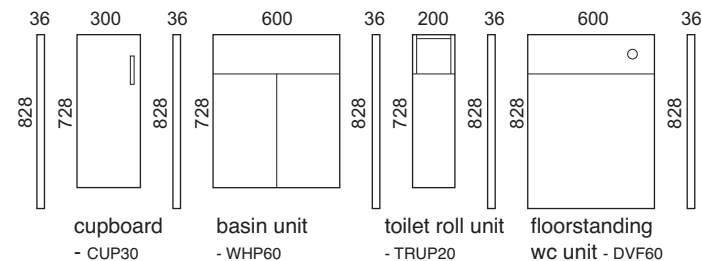
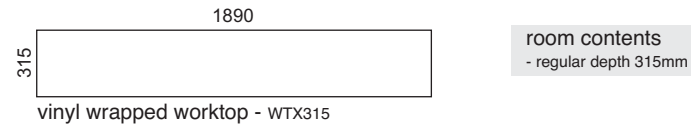
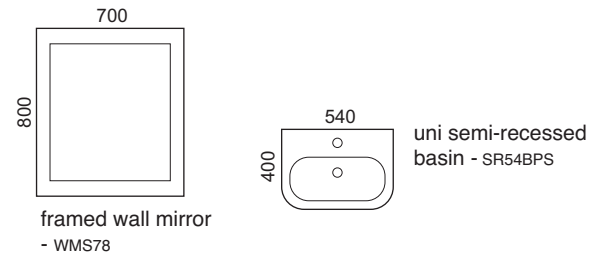

36mm traditional framing panels (x2) - seen end - TRF82SE

36mm traditional framing panels (x3) - intermediate panel - TRF82IP

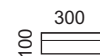

36mm traditional framing panels - plinth - TRF30PL

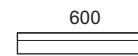

36mm traditional framing panels - plinth - TRF60PL



36mm traditional framing panels - plinth - TRF20PL

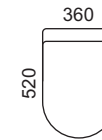

uni back to wall wc suite - BTWC3COMP

room contents - regular depth 315mm



handle H41



worktop

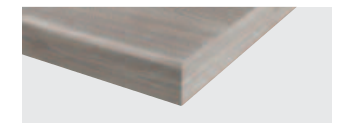

nordic grey vinyl wrapped

door



soft ivory

carcase



nordic grey

units available 100mm / 244mm plinth or wall hung

eton door finishes
page 10



18

door styles
page 8



11

worktop finishes
pages 100-105



57

carcase finishes
page 11

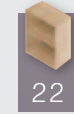

22

handle options
pages 12-13



30

your choices - to room contents shown



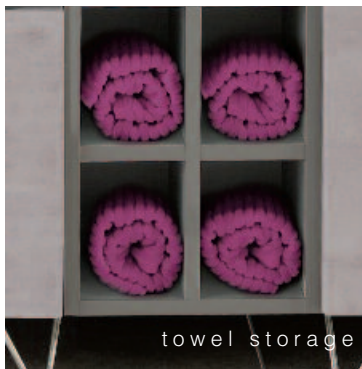

FEATURE FOCUS

towel storage - adding both a design feature and practical storage solution, these units are available in a number of widths & heights, to integrate as part of your overall bathroom layout.

hair pin legs - a decorative and functional support for both freestanding and inline furniture. Available in heights of 100mm or 250mm in chrome or matt black finish. (supplied with floor contact protectors for a perfect fit and load spreading on tiles).

undertop - an attractive and useful addition to wall cabinets with adjacent mirrors.

room contents

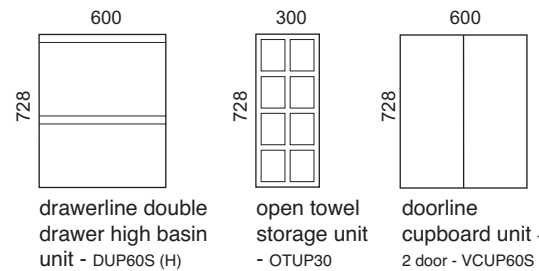
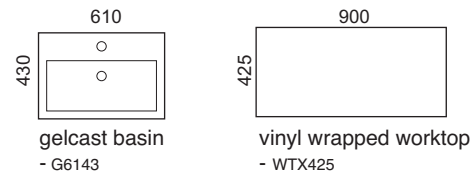
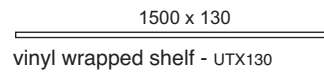
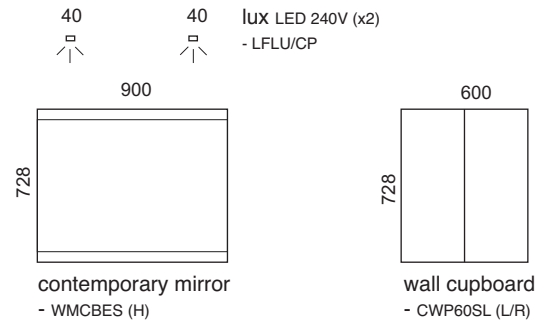

room contents
- full depth 425mm
- regular depth 315mm
- slimline depth 130mm



worktop

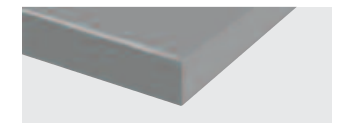

dust grey vinyl wrapped

door



concrete

carcase



dust grey

units available 100mm / 244mm plinth or wall hung

handles milan door finishes
page 10

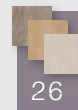

door styles
page 8



worktop finishes
pages 100-105

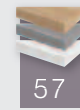

carcase finishes
page 11



handle options
pages 12-13



your choices - to room contents shown



handless nu-mont

door STYLE



FEATURE FOCUS

handless nu-mont door style - don't want handles choose one of Montrose's handless door styles, for that clean simple look. A concealed chamfer to the rear of the door allows easy opening & contrasting carcass creates a great design effect.

cut backs - provide a pleasing design feature, whilst also proving practical where space is more limited. For instance when back to wall WC's are being fitted cutting back to say Spacesaver depth reduces the overall projection & provides easier access.

additional glass shelves - open shelf wall units can be requested with extra glass shelves (2 number), please ask your dealer to specify at the time of order should this option be required.



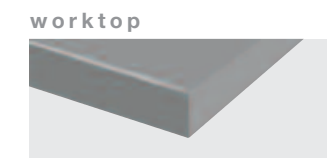
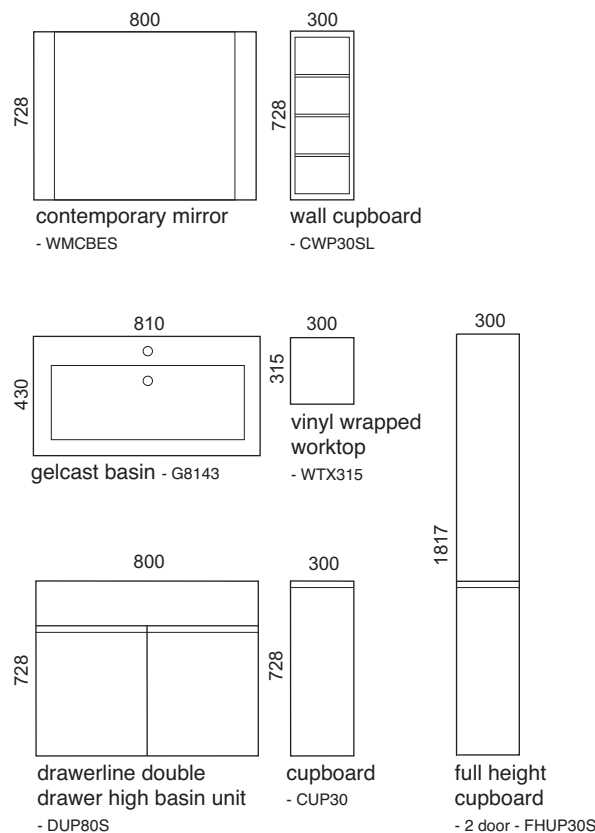

room contents

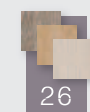

room contents

- full depth 425mm
- regular depth 315mm
- spacesaver depth 225mm
- slimline depth 130mm

units available 100mm / 244mm plinth or wall hung

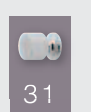
<p>handless nu-mont door finishes</p> <p>page 10</p>  <p>26</p>	<p>door styles</p> <p>page 8</p>  <p>11</p>	<p>worktop finishes</p> <p>pages 100-105</p>  <p>57</p>	<p>carcase finishes</p> <p>page 11</p>  <p>22</p>	<p>handle options</p> <p>pages 12-13</p>  <p>31</p>
--	--	--	--	--

your choices - to room contents shown





cantilever shelving



neostone basin

FEATURE FOCUS

cantilever shelving - varying depths, lengths & thicknesses available, in a range of finishes to match or contrast with your Montrose furniture, providing a display space for your own finishing touches.

integrated basins - available with either Corian or Neostone worktops, these basins provide a seamless movement from worktop to basin. With a number of bowl options, related to furniture that they are being used with, these basins give both a practical & luxurious feel to your room.

room contents

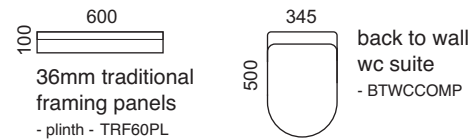
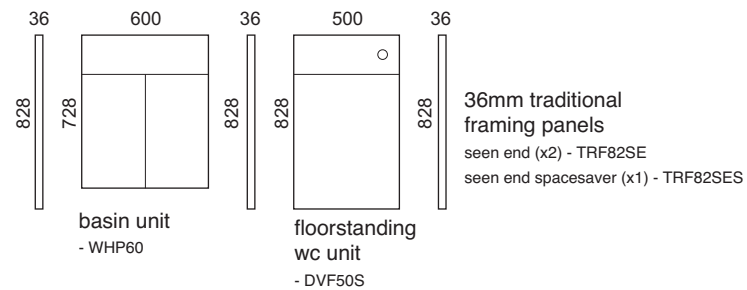
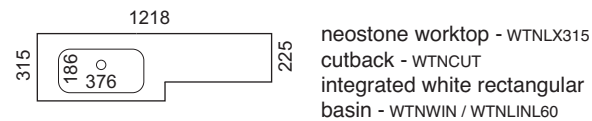
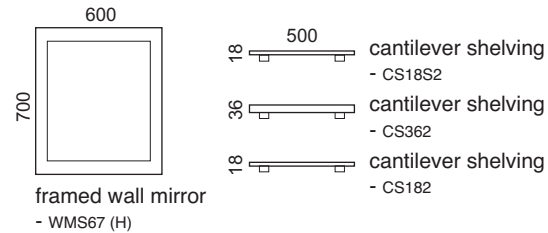

room contents
- regular depth 315mm
- spacesaver depth 225mm



handle H71

worktop

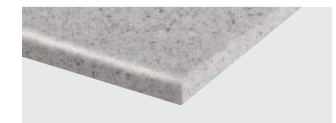

12mm grey quartz neostone

door



cashmere elm

carcase



cashmere elm

units available 100mm / 244mm plinth or wall hung

heritage door finishes page 10



door styles page 8



worktop finishes pages 100-105



carcase finishes page 11

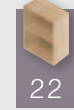

handle options pages 12-13

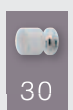

your choices - to room contents shown





100mm rear upstand

FEATURE FOCUS

rear upstand - a matching finish 100mm or 200mm upstand is available when selecting Neostone worktops. Manufactured from 12mm neostone material, this feature offers a water tight finish to the wall & enhances the overall look of the finished installation.



angled cutback unit

angled cut back unit - this piece of furniture allows for a change in unit depth, to be handled as a gentle progression, with either a single door or open shelf versions of the unit, extra storage with added style.

room contents

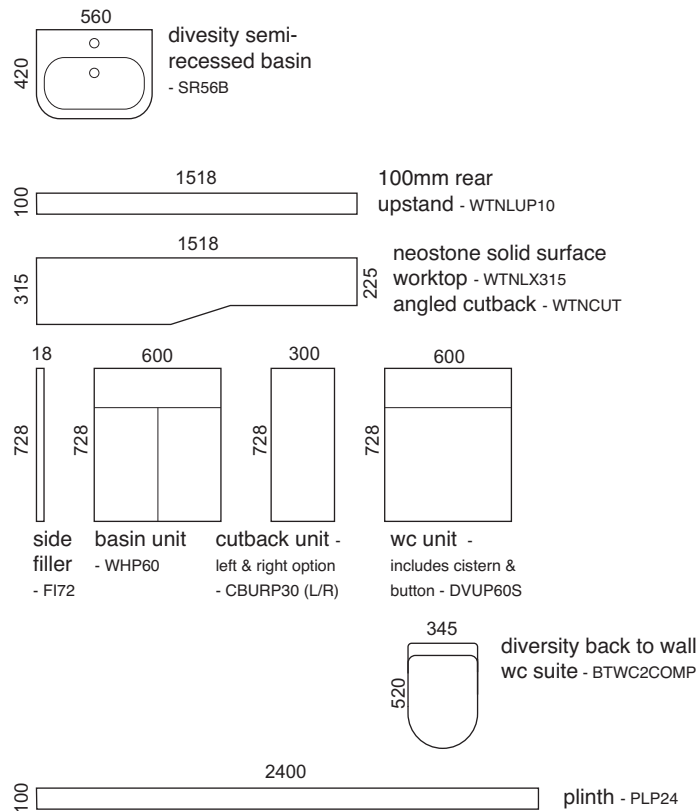

room contents
- regular depth 315mm
- spacesaver depth 225mm

units available 100mm / 244mm plinth or wall hung



horizontal grain
also available
- see page 10

handle
H79

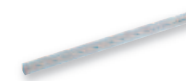

worktop & upstand



12mm crystal neostone

door

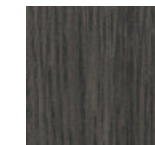

midnight oak

carcase

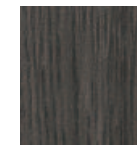

midnight oak

milan door
finishes
page 10



26

door
styles
page 8



11

worktop
finishes
pages
100-105

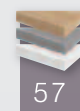

57

carcase
finishes
page 11



22

handle
options
pages
12-13



30

your choices - to room contents shown





FEATURE FOCUS

upper & undertop LED strip lighting - integrated into the specified size top & fitted with opaque diffusers, this feature gives rooms a finishing touch, as well as having it's practical uses.

coloured backs - add an extra splash of colour to your bathroom - shown here Storm Grey, with 6 contrasting finish options (see page 90) this feature allows you to express your individuality, change an open unit display into a real showcase.

push to open - our alternative opening option for doors & drawers, means handles become a thing of the past & a sleek, clean look is the result (not available for mirror cabinet doors).

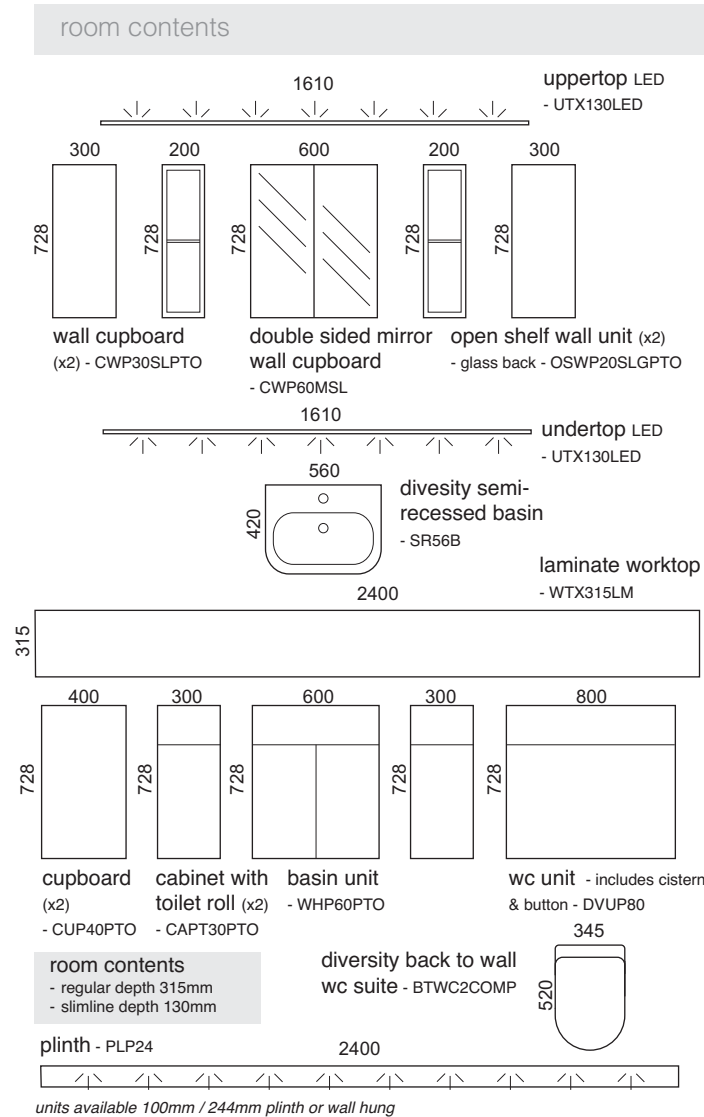

worktop

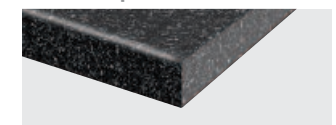

astral laminate

door



hi gloss white

carcase

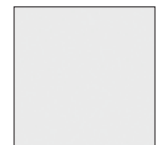

soft white

milan door finishes
page 10 26

door styles
page 8 11

worktop finishes
pages 100-105 57

carcase finishes
page 11 22





FEATURE FOCUS

dual finish fronts - with units that feature an upper & lower front, it is possible for them to be pressed in different finishes, as shown in the main image. All the upper fronts are dust grey but the lower ones are finished in white oak, please ask your dealer to specify at the time of order should this option be required.

additional glass shelves - open shelf wall units can be requested with extra glass shelves (2 number), please ask your dealer to specify at the time of order should this option be required.

room contents

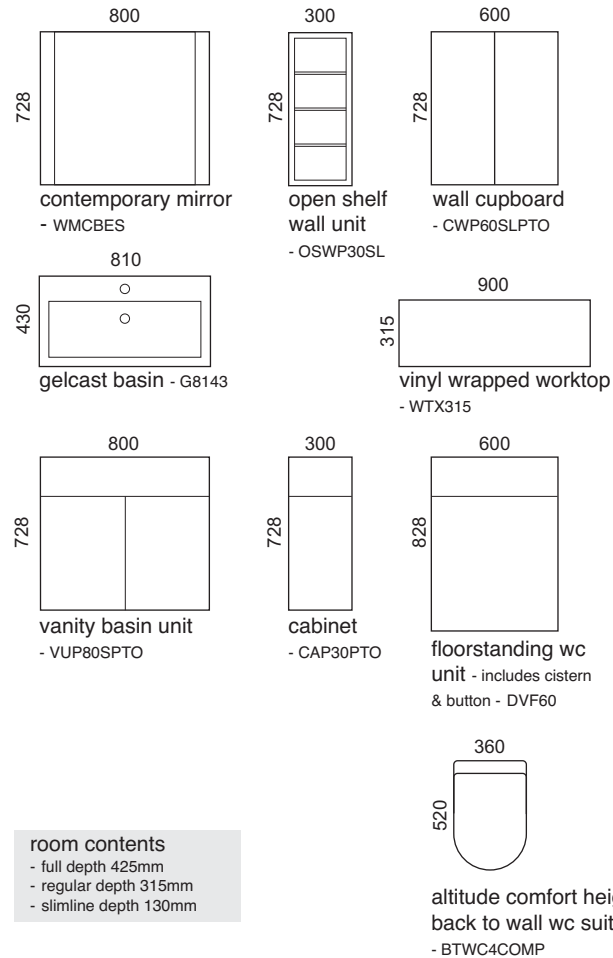

room contents

- full depth 425mm
- regular depth 315mm
- slimline depth 130mm

units available 100mm / 244mm plinth or wall hung



worktop

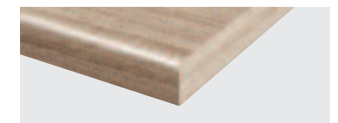

vintage oak vinyl wrapped

door



vintage oak / dust grey

carcase



dust grey / vintage oak

nu-mont
door
finishes
page 10

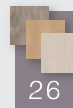

door
styles
page 8



worktop
finishes
pages
100-105

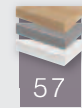

carcase
finishes
page 11

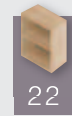

your choices - to room contents shown





FEATURE FOCUS

wall hung - with all our units customers have the choice of wall hanging the units (brackets supplied as standard) meaning that no plinth is required. Installing the furniture like this generally makes the room look larger, as more floor area is visible & this likewise assists cleaning.

dedicated handle - the Orbit doorstyle features a dedicated strap handle, which gives the design a bold & distinctive look but is also practical, as it is extremely easy to grasp hold of.

slimline - depth units, where available space is tight, Montrose can offer a range of unit depths which deal with & make the most of any size room. With unit depths of 130mm, 225mm, 315mm, 425mm & 575mm, a whole host of options become available to your architect or bathroom designer.

room contents

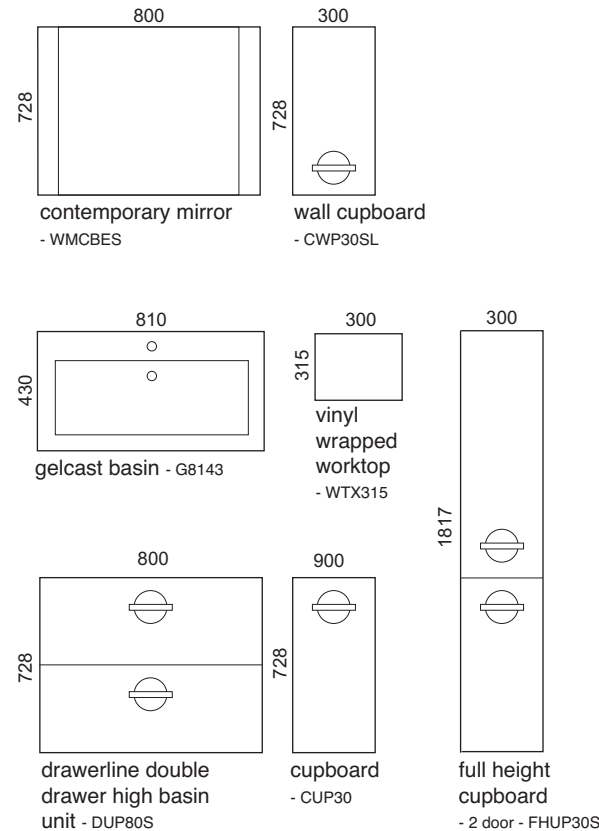

handle
H83
exclusive to Orbit

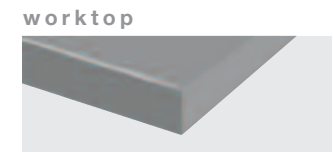

dust grey vinyl wrapped



door
dust grey



carcase
vintage oak

room contents
- full depth 425mm
- regular depth 315mm
- spacesaver depth 225mm
- slimline depth 130mm

units available 100mm / 244mm plinth or wall hung

orbit door
finishes
page 10



door
styles
page 8

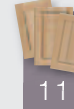

worktop
finishes
pages
100-105



carcase
finishes
page 11

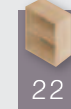

your choices - to room contents shown





blok cornice

FEATURE FOCUS

blok cornice - the perfect finish to your wall units. Supplied in varying lengths & then cut to size, blok cornice gives the impression that your wall units are all as one, completing that fitted look.

full height angled corner unit - is storage space key to your design, well this unit will afford you with a huge potential, while also providing an attractive corner feature for the room layout.

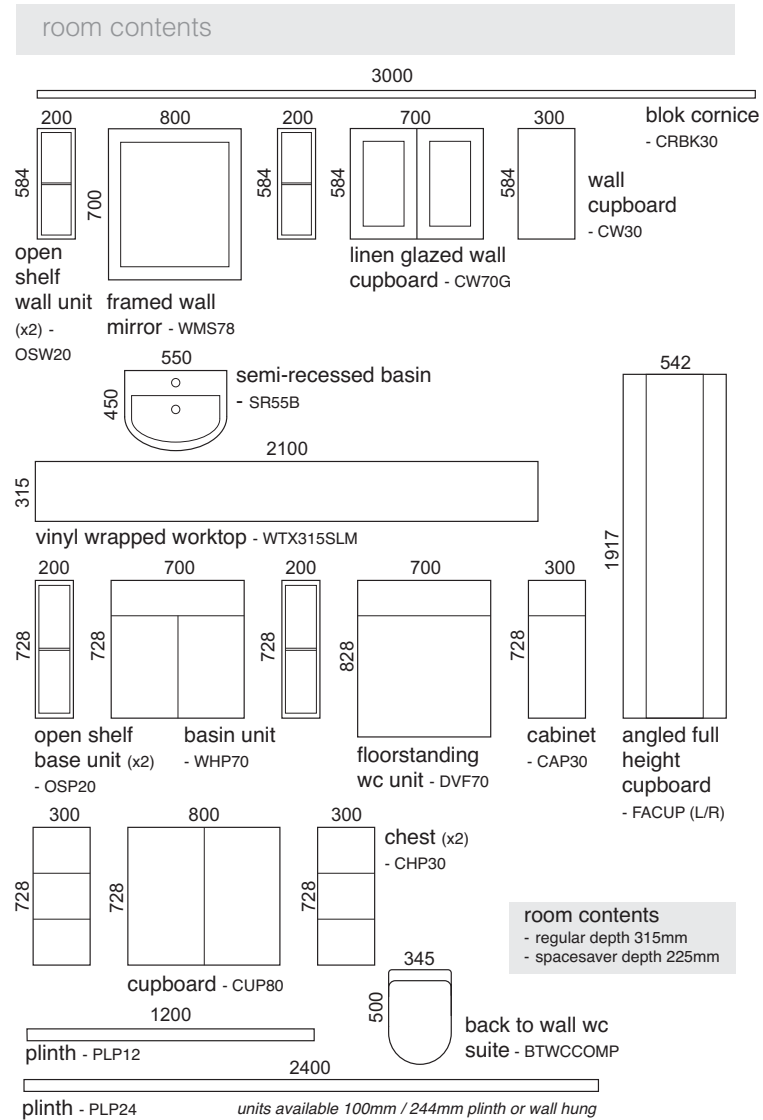

handle
H21



worktop

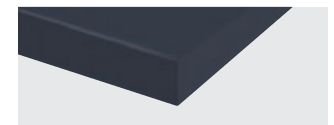

blue indigo vinyl wrapped

door



blue indigo

carcase



argento beech

room contents
- regular depth 315mm
- spacesaver depth 225mm

portland
door
finishes
page 10

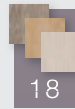

18

door
styles
page 8



11

worktop
finishes
pages
100-105

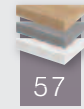

57

carcase
finishes
page 11



22

handle
options
pages
12-13

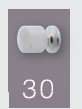

30





FEATURE FOCUS

floorstanding wc unit - removes the need for plinth leaving a neat gap free finish to any back to wall wc pan, that you might choose to use. Available with & without dual flush 3/6 litre cistern.

room contents

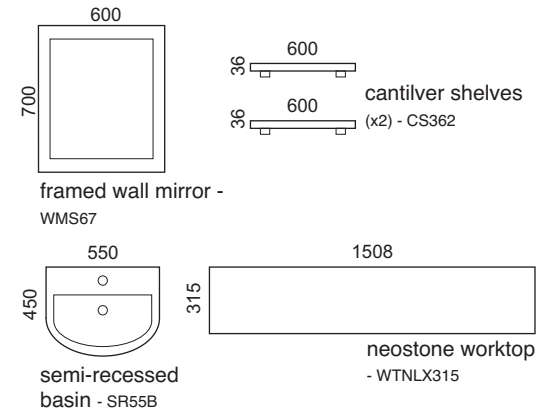

36mm traditional framing panels

- intermediate panel (x1) - TRF82IP
- seen end (x1) - TRF82SE
- spacesaver seen end (x1) - TRF82IPS

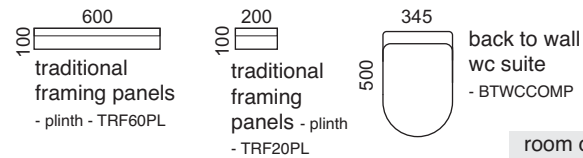
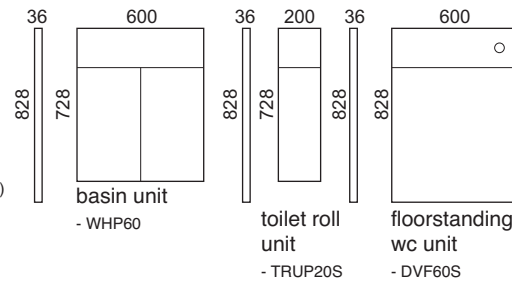

room contents

- regular depth 315mm
- spacesaver depth 225mm

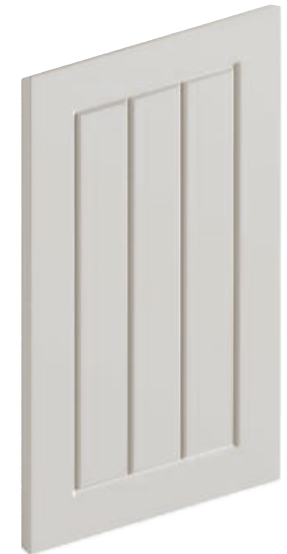

handle
H76/SS



worktop

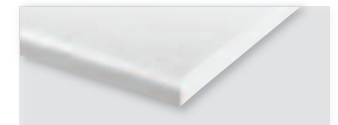

12mm crystal neostone

door



light grey

carcase



light grey

units available 100mm / 244mm plinth or wall hung

suffolk
door
finishes
page 10



door
styles
page 8



worktop
finishes
pages
100-105

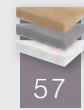

carcase
finishes
page 11



handle
options
pages
12-13



your choices - to room contents shown



corner-line basin unit

curved milan door STYLE



curvature framing

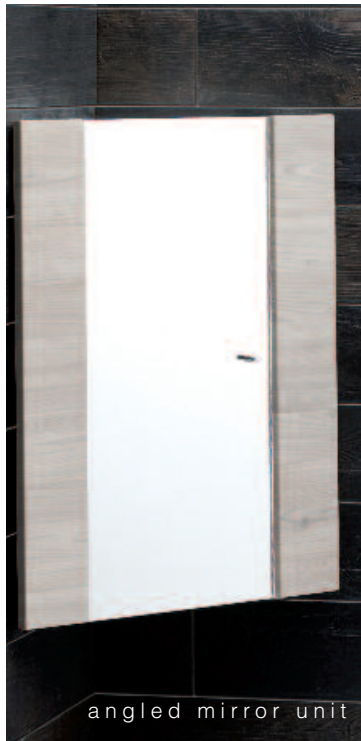

angled mirror unit

FEATURE FOCUS

curvature framing panels - make the doors & drawers of your Montrose bathroom furniture seem flush to the carcass, they also provide an opportunity to create a great contrasting look, when a different finish is used to the fronts finish. With a number of options, including curved & traditional, framing panels offer truly individual styling.

angled corner unit - perfect for fitting above basins which are located into a corner, providing a mirror which you can look into directly & storage behind. Available in 2 heights & finishes to match or contrast with those chosen elsewhere in the room.

room contents

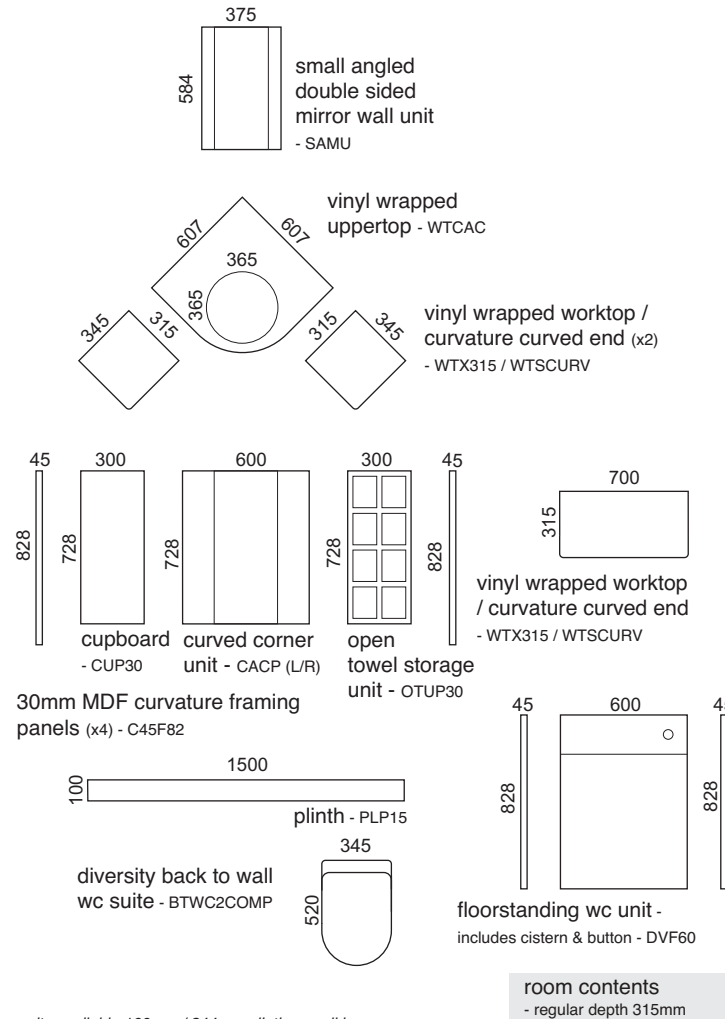

units available 100mm / 244mm plinth or wall hung



vertical grain also available - see page 10

handle H39

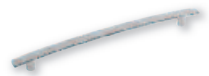

worktop

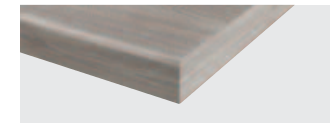

nordic grey vinyl wrapped

door



nordic grey

carcase



soft white

curved milan door finishes
page 10

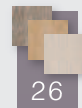

worktop finishes
pages 100-105



carcase finishes
page 11



handle options
pages 12-13

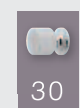

your choices - to room contents shown



D-line basin unit

curved milan door STYLE



FEATURE FOCUS

d-line - introduce curves into your room, why have just a straight run of furniture, when introducing a curved unit can add interest & also extra storage space, ask your designer what options might be possible for your bathroom.

curved end units - why come to a straight finish when you can do it with a curve? Whether its related to space or just to enhance the look of your layout, Montrose have a range of open shelf & 1 door curved end units which are perfect.

storage bath panel - looking for even more storage space, got a bath in your home, well why not make better use of the area under it. The Montrose storage bath panel lets you do just that, with a hinged door to the panel, allowing access to chrome storage baskets which are positioned to the underside of the bath.

room contents

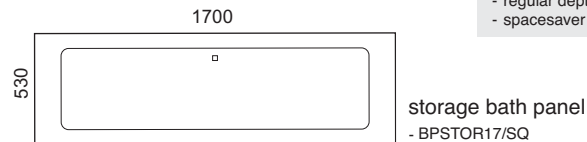
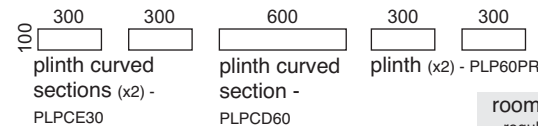
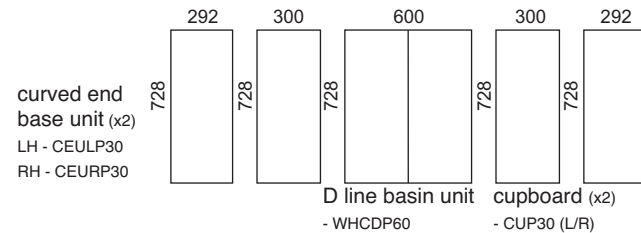
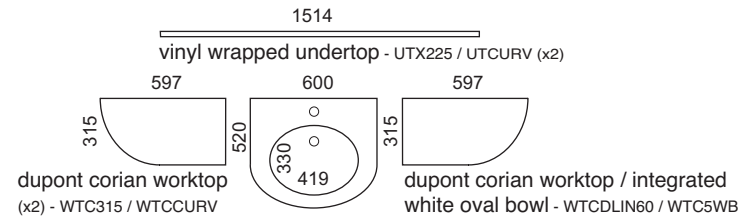
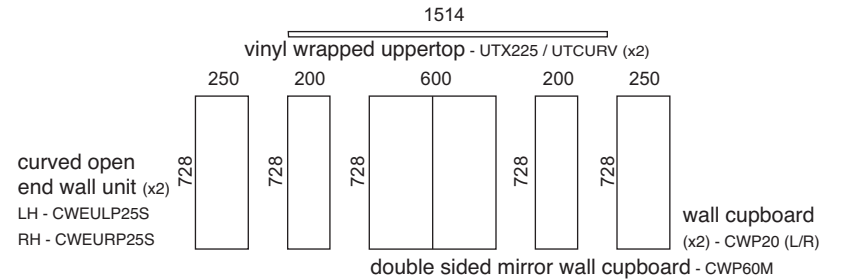

units available 100mm / 244mm plinth or wall hung



handle H39

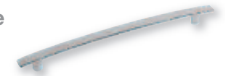

worktop



door



carcase

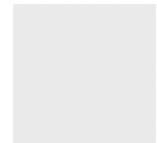

room contents
- regular depth 315mm
- spacesaver depth 225mm

curved milan door finishes
page 10

26

worktop finishes
pages 100-105

57

carcase finishes
page 11

22

handle options
pages 12-13

30

your choices - to room contents shown



D-line basin unit

curved milan door STYLE



FEATURE FOCUS

coloured glass backs - add an extra splash of colour to your bathroom - shown here Metal Taupe. With 6 contrasting finish options this feature allows you to express your individuality, change an open unit display into a real showcase.

wall hung wc pans - contemporary design & practicality all in one product. Visible floor area means the perception of more space, installing a wall hung wc pan will only assist with this perception. It will also help with cleaning, as now the floor is one big open space in this area.

room contents

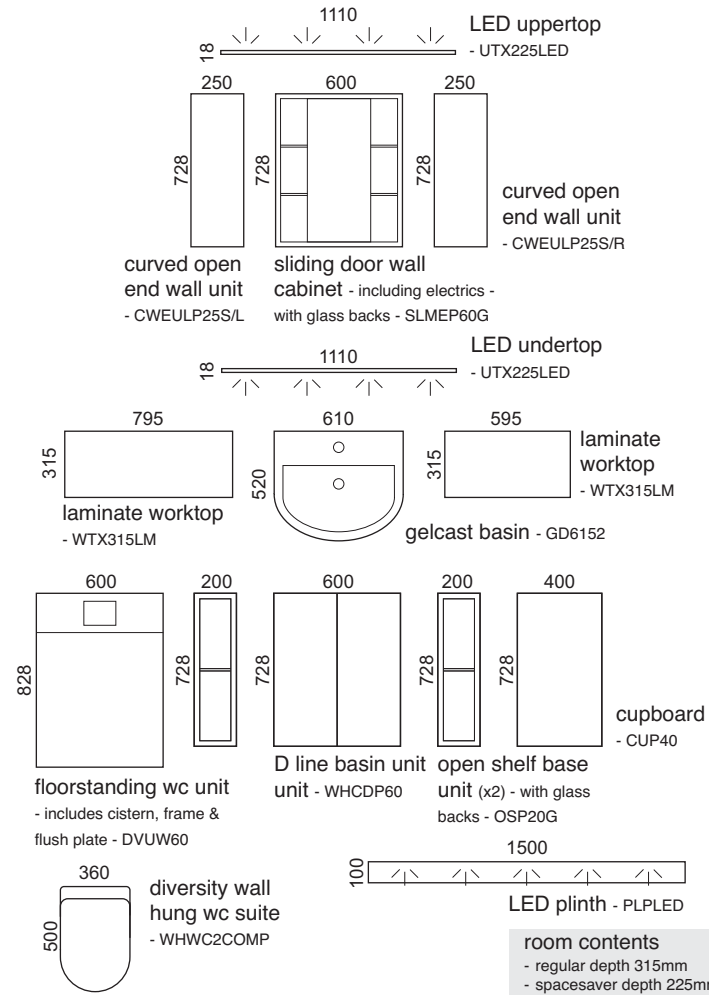

handle H17/N

worktop

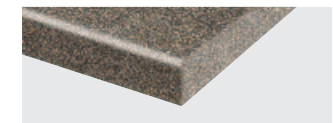

night sparkle laminate

door



vintage oak

carcase



vintage oak

units available 100mm / 244mm plinth or wall hung

curved milan door finishes page 10

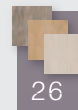

worktop finishes pages 100-105



carcase finishes page 11



handle options pages 12-13

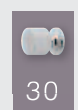

your choices - to room contents shown



S-line basin unit

curved milan door STYLE



integrated basin

FEATURE FOCUS

integrated basins - available with either Corian or Neostone worktops, these basins provide a seamless movement from worktop to basin. With a number of bowl options, related to furniture that they are being used with, these basins give both a practical & luxurious feel to your room.

room contents

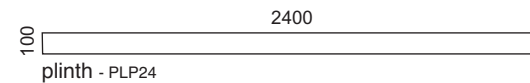
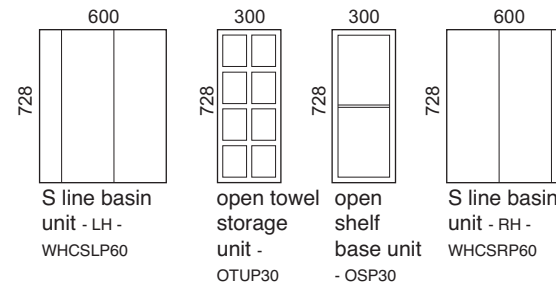
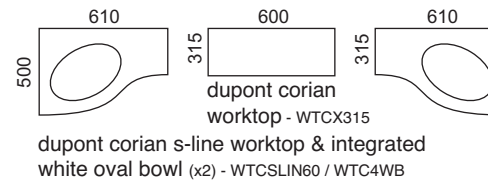
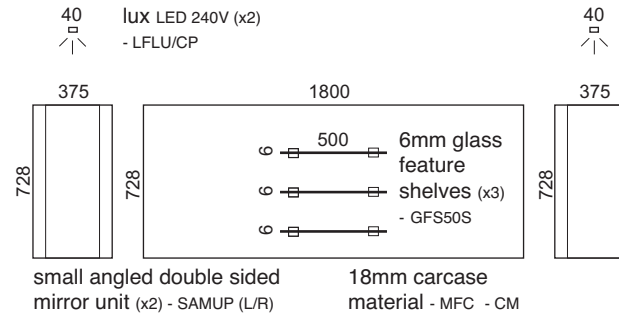

room contents
- regular depth 315mm

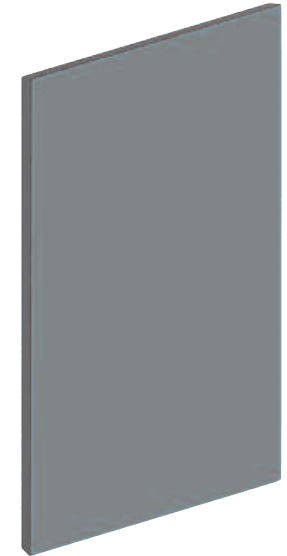

handle
H56



25mm everest corian



units available 100mm / 244mm plinth or wall hung

curved milan door finishes
page 10

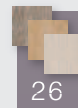

worktop finishes
pages 100-105



carcass finishes
page 11



handle options
pages 12-13

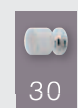

your choices - to room contents shown

cloakroom wc

feature



room contents

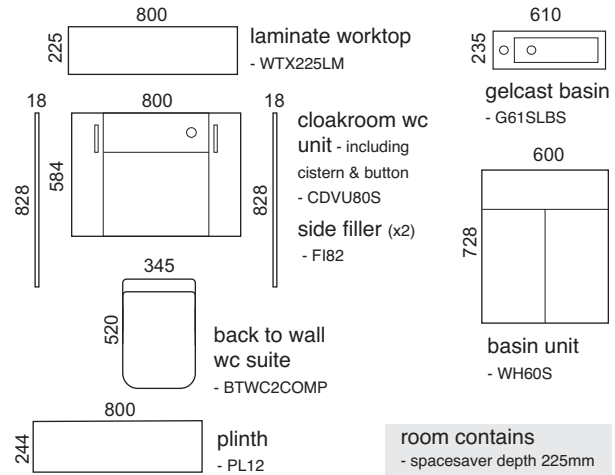

milan
door STYLE
vertical grain also
available - see page 10



handle
H39







worktop
glitter bianco laminate



door carcass
mali wenge mali wenge



units available 100mm / 244mm plinth or wall hung

- 
milan door finishes
 page 10
- 
door styles
 page 8
- 
worktop finishes
 pages 100-105
- 
carcass finishes
 page 11
- 
handle options
 pages 12-13

your choices - to room contents shown

cloakroom wc

feature



room contents

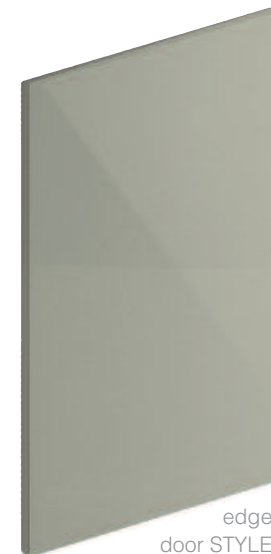
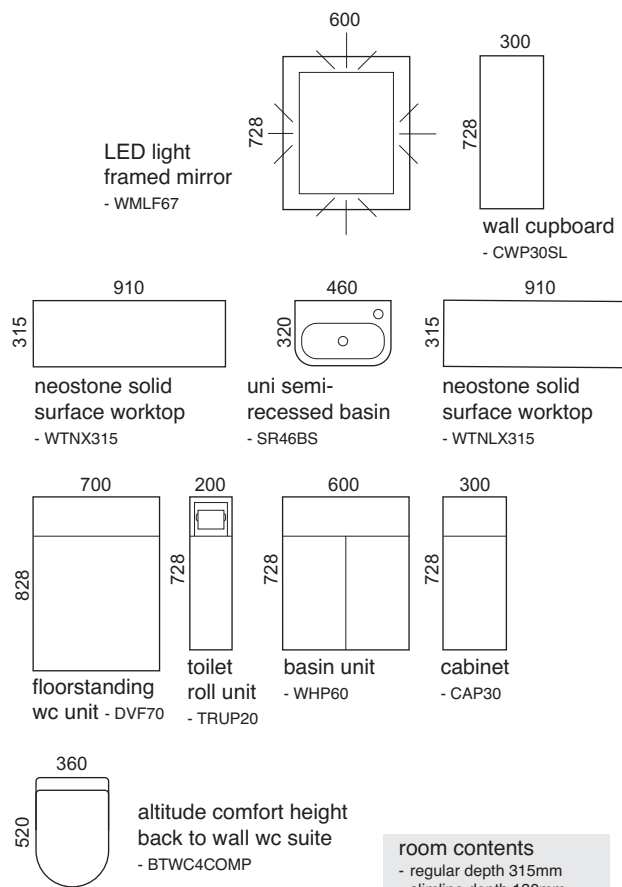

handle H84 - reed green

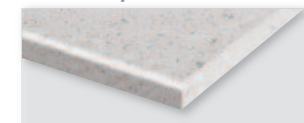
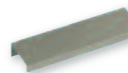

12mm neostone alaskan

door



super matt reed green

carcase

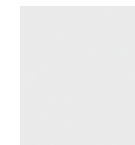

soft white

units available 100mm / 244mm plinth or wall hung

edge door finishes
page 10

door styles
page 8

worktop finishes
pages 100-105

carcase finishes
page 11

handle options
pages 12-13

22

30

your choices - to room contents shown



floating units

handless milan door STYLE



FEATURE FOCUS

floating units - less is more, create stunning designs with a combination of wall mounted units with worktops used above & below, to give that floating effect as seen in the image opposite - let your imagination take hold.

worktop towel rail bracket - a smart chrome towel rail bracket which also supports the worktop, where there is no unit to do so.

aura LED lighting - low energy LED light for direct connection to 240V supply. Great addition to mirrors or above wall units, fixing bracket allows for either installation.

room contents

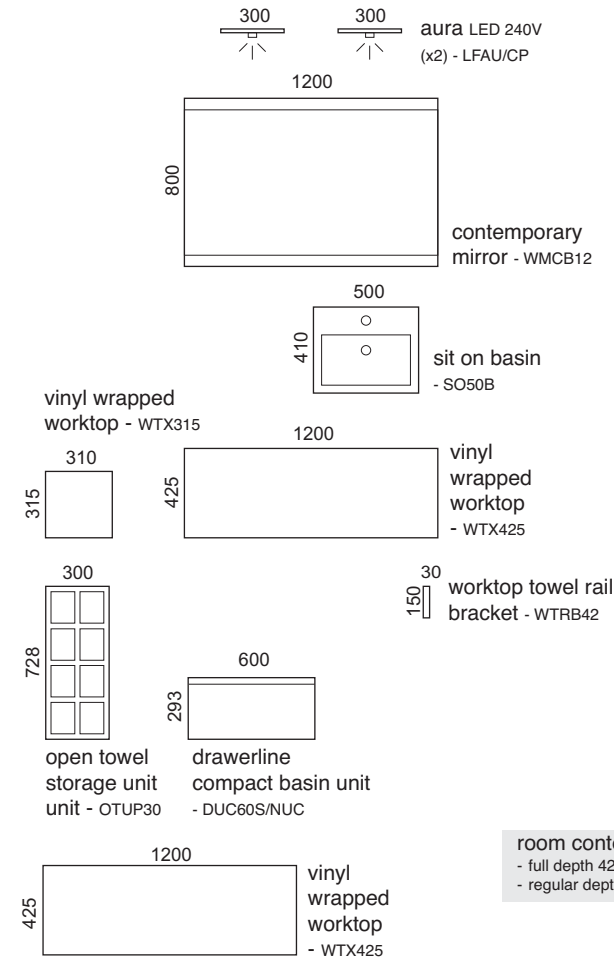

worktops

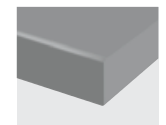
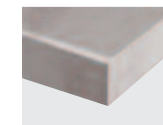

door



room contents
- full depth 425mm
- regular depth 315mm

units available 100mm / 244mm plinth or wall hung

handless milan door finishes
page 10

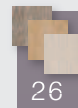

door styles
page 8



worktop finishes
pages 100-105

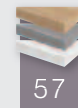

carcase finishes
page 11

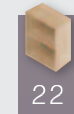

handle options
pages 12-13

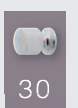

your choices - to room contents shown





FEATURE FOCUS

Painted vinyl - providing you with the opportunity of a truly bespoke look, choose from any of the above door styles (all can be pressed in paintable vinyl), then select a recognised paint finish from your favourite brand & our paint shop will manufacture your doors to match, in a luxurious Matt Satin finish. Complete the look with clad on end panels, plinths, fillers & worktops to match or compliment with mirrors & bath panels. Whilst painted options do come at a slightly higher price, they allow you to set your design & imagination free.

Painted doorstyle options



choose your colour
matt or matt grained vinyl

available door styles as shown
above & in matrix page 11 - finished
to match most popular paint finishes



Painted door finishes
page 10



door styles
page 8



worktop finishes
pages 100-105



carcase finishes
page 11



handle options
pages 12-13



inline & fitted cabinet types

quick reference guide

basin units

full depth 425mm only

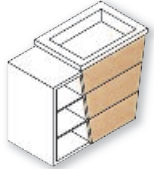

V line basin unit
- inline / stand alone
LH & RH
80cm width **GC CT**

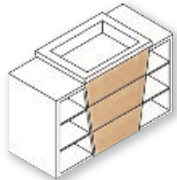

V line basin unit
- inline / stand alone
100cm width **GC CT**



lo-line 1 drawer
compact basin unit
50-100cm widths **SO**

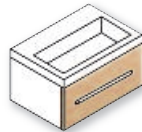

hi-line 1 drawer
compact basin unit
50-120cm widths **GC**

basin units

full depth 575mm, 425mm & 460mm*



hi-line 2 door vanity
basin unit
60-90cm widths **GC CT**



lo-line 2 door basin unit
60-90cm widths **SO**



hi-line 2 high
door basin unit
60-120cm widths **GC CT**
SO indigo basin only

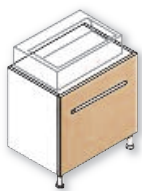

lo-line high drawer
basin unit
60-160cm widths **SO**



hi-line high drawer
basin unit
60-160cm widths **GC CT**

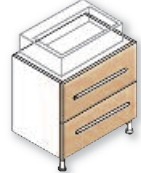

lo-line double drawer
basin unit
60-160cm widths **SO**



hi-line double drawer
basin unit
60-160cm widths **GC CT**
*also 460mm depth
SO indigo basin only

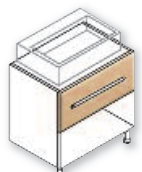

lo-line drawer & open
shelf basin unit
60-120cm widths **SO**

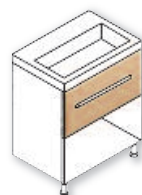

hi-line drawer
& open shelf
basin unit
60-120cm widths **GC CT**
SO indigo basin only

base units

full depth 575mm & 425mm



curved end base /
cupboard low unit
- left & right option
30cm width



open shelf base
low unit
15-70cm widths



curved end base /
open low unit
- left & right option
30cm width



doorline low cupboard
unit - single
30-45cm widths



doorline low cupboard
unit - double
50-90cm widths

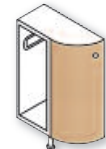

curved end base /
towel low unit
- left & right option
30cm width

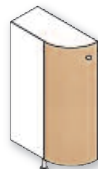

curved end base /
cupboard unit
- left & right option
30cm width

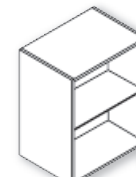

open shelf base
unit full depth
15-70cm widths

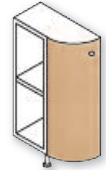

curved end base /
open unit
- left & right option
30cm width

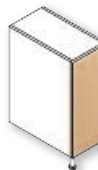

doorline cupboard
- single
20-45cm widths

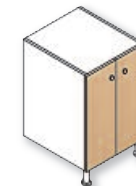

doorline cupboard
- double
50-90cm widths

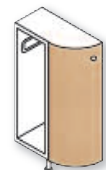

curved end base /
towel unit
- left & right option
30cm width

Suitable basin types key

CT. countertop



SO. sit on



SR. semi-recessed



GC. gelcast



cabinet types

quick reference guide

basins units

regular depth 315mm only



recessed 1
drawer basin unit
50-90cm widths
SR GC



recessed 2
drawer basin unit
50-90cm widths
SR GC

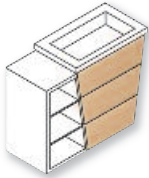

V line basin unit
- inline / stand
alone LH & RH
80cm width **GC**

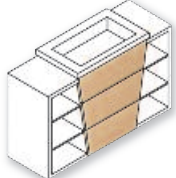

V line basin unit
- inline / stand
alone
100cm width **GC**



angled vanity unit
73cm width **SR CT**

basins units

regular depth 315mm
& space saver depth 225mm



recessed 2
door basin unit
50-90cm widths
SR GC



basin unit
integrated bowls
60-80cm widths
GC CT



doorline high
basin unit
45-60cm widths
GC



D line basin unit
60cm width **GC CT**

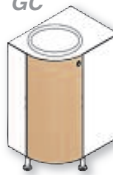

curved corner basin
unit - unequal ends
52-61cm widths **CT**

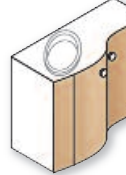

S line basin unit
- left & right option
60cm width **GC CT**

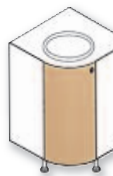

curved corner basin unit
52-61cm widths **CT**

wc units

regular depth 315mm & space saver depth 225mm

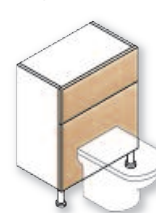

wc units - btw wc pans
50-90cm widths

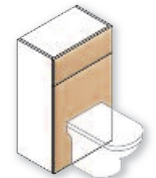

floorstanding wc unit
- btw wc pans
50-90cm widths



floorstanding wc unit
- wall hung wc pans
50-90cm widths

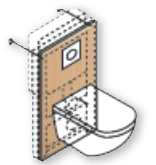

floorstanding wall panel
- inc cistern, frame, flush
plate & wall hung wc pan
60cm width

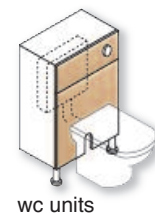

wc units
- inc cistern & button
- btw wc pans
50-90cm widths



floorstanding wc unit
- inc cistern & button
- btw wc pans
50-90cm widths

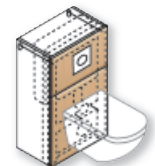

floorstanding wc unit
- inc cistern, frame
& flush plate
- wall hung wc pans
60-90cm widths

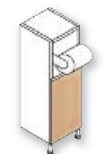

toilet roll unit
20cm width

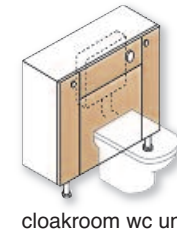

cloakroom wc unit
- inc cistern & button
- btw wc pans
80cm width

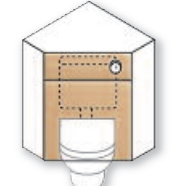

angled floorstanding
wc unit - inc cistern &
button - btw wc pans
57-66cm widths

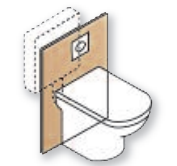

floorstanding wall
panel
- inc cistern, flush
plate & btw wc pan
60cm width



cabinet with toilet roll
20cm width

full height wc units

regular depth 315mm &
space saver depth 225mm

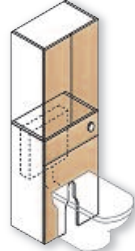

floorstanding wc unit
- inc cistern & button
- btw wc pans
60-90cm widths

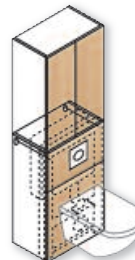

floorstanding wc unit
- inc cistern, frame &
flush plate
- wall hung wc pans
60-90cm widths

bidet unit

regular depth 315mm



bidet unit
50-90cm widths

Suitable basin types key

CT. countertop



SO. sit on



SR. semi-recessed



GC. gelcast



Please note all depths quoted in quick reference guide are maximums, therefore include worktop or upertop with overhang.
The widths shown are minimums and maximums, 5cm or 10cm increments apply depending on unit type. For full dimensions of units please refer to retail price list.

inline & fitted cabinet types

quick reference guide

base units

regular depth 315mm & space saver depth 225mm



low cupboard
- single
30-45cm widths



low cupboard
- double
50-90cm widths



angled open
end base unit
20cm width

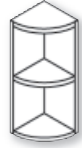

curved open end
base unit
23-27cm widths



curved end
base unit
- left & right option
25-30cm widths



open shelf
cutback unit
- left & right option
30cm width



cutback unit
-left & right option
30cm width

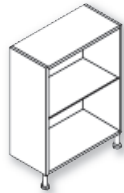

open shelf
base unit
15-70cm widths

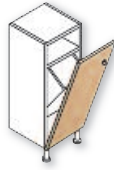

bin unit
30cm width

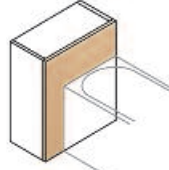

bath header unit
73-88cm widths



cupboard - single
15-45cm widths



cupboard - double
50-90cm widths

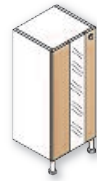

cupboard mirage
- single
30-45cm widths



angled base unit
42-52cm widths

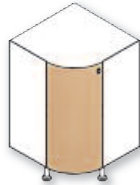

curved corner unit
52-61cm widths



curved corner unit
- unequal ends
52-61cm widths



corner cupboard
base unit
- left & right option
60cm width



tall base cupboard
30-45cm widths

base units

regular depth 315mm only



open towel
storage unit
- single
30cm width



open towel
storage unit
- double
60cm width

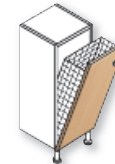

laundry basket
35cm width



cabinet - single
30-45cm widths



cabinet - double
50-90cm widths

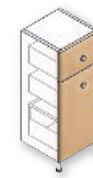

double drawer
chest - single
30-45cm widths



double drawer
chest - double
50-90cm widths

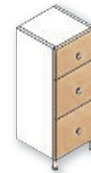

chest - single
30-45cm widths



chest - double
50-90cm widths



angled corner
cupboard
73cm width



tall open towel
storage unit
- single
30cm width

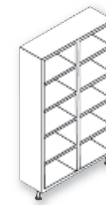

tall open towel
storage unit
- double
60cm width

full height base units

regular depth 315mm only



angled full height
cupboard
55cm width



angled full height
cupboard
- concealed soil pipe
55cm width

cabinet types

quick reference guide

full height base units

regular depth 315mm & spacesaver depth 225mm



full height open shelf unit
30-35cm widths

full height cupboard - 2 door
30-35cm widths

wall units

regular depth 315mm, spacesaver depth 225mm & slimline depth 130mm

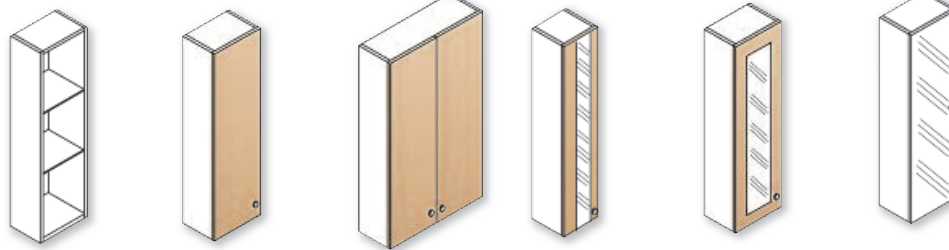

tall open shelf unit
20-35cm widths

tall wall cupboard - single
30-45cm widths

tall wall mirage cupboard
30-35cm widths

linen glazed tall wall cupboard
30-45cm widths

double sided mirror tall wall cupboard - single
30-35cm widths

double sided mirror tall wall cupboard - double
30-35cm widths

wall units

spacesaver depth 225mm, spacesaver depth 175mm & slimline depth 130mm

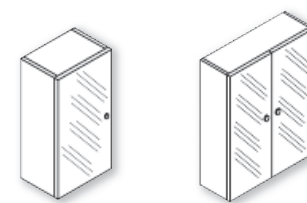

double sided mirror wall cupboard - single
30-35cm widths

double sided mirror wall cupboard - double
60-70cm widths

wall units

spacesaver depth 225mm only



sliding mirror cabinet
60-120cm widths

wall units

spacesaver depth 225mm only

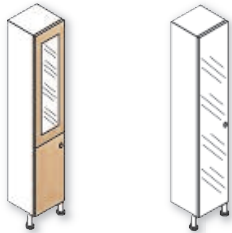

linen glazed full height cupboard - 2 door (1 linen glazed)
30-35cm widths

double sided mirror full height cupboard - 1 door
30-35cm widths

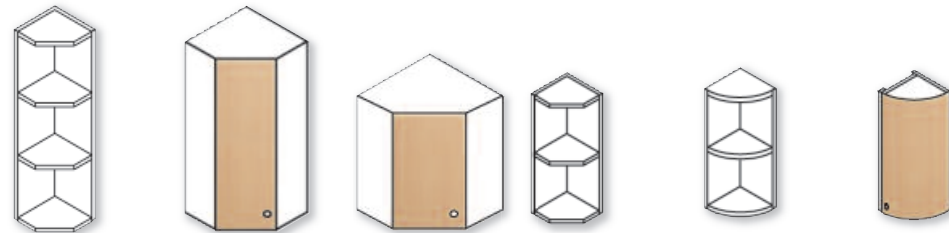

tall angled open end wall unit
20cm width

tall angled wall cupboard
42cm width

angled wall cupboard
42cm width

angled open end wall unit
20cm width

curved open end wall unit
23cm width

curved end wall unit - left & right option
25cm width

wall units

spacesaver 200mm & 150mm

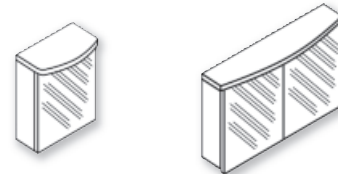

standard mirror unit - single
50-60cm widths

standard mirror unit - double
100-120cm widths

wall units

spacesaver depth 225mm only



salire mirror unit
120cm width

wall units

spacesaver depth 225mm & slimline depth 130mm

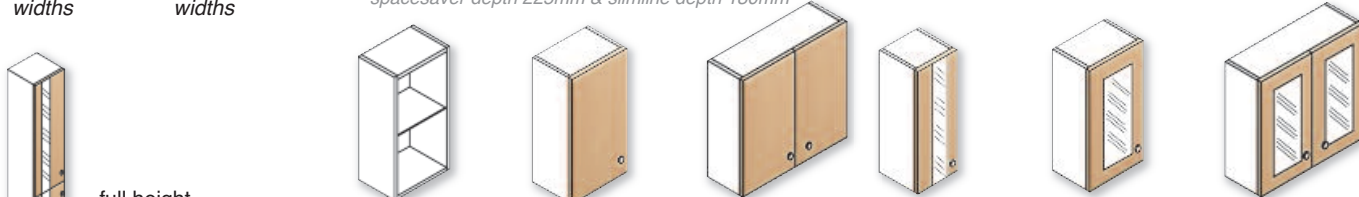

full height cupboard mirage - 2 door
30-35cm widths

open shelf wall unit
15-70cm widths

wall cupboard - single
15-45cm widths

wall cupboard - double
50-90cm widths

wall cupboard mirage - single
30-45cm widths

linen glazed wall cupboard - single
30-50cm widths

linen glazed wall cupboard - double
60-90cm widths

deluxe mirror unit - single
50-60cm widths

deluxe mirror unit - double
100-120cm widths

small angled double sided mirror unit
38cm width

Please note all depths quoted in quick reference guide are maximums, therefore include worktop or uppertop with overhang. The widths shown are minimums and maximums, 5cm or 10cm increments apply depending on unit type. For full dimensions of units please refer to retail price list.

unit types & accessories

open shelf base & wall units



angled units



angled cut back unit

angled full height cupboard
(also for concealed soil pipe)

curved units



colour options - glass backs



towel storage unit



bath header unit



linen glazed units

unit types & accessories



laundry basket - 728mm height unit also has internal shelf



basin towel rail bracket



hairpin legs



shaver socket



glass feature shelves



cabinet with toilet roll



toilet roll unit

unit types & accessories



bin unit



cantilever shelving



pull out towel rail



framed mirror



deluxe mirror
& backboard 800mm



deluxe mirror
& backboard 1174mm



full wall mirror



u mirror

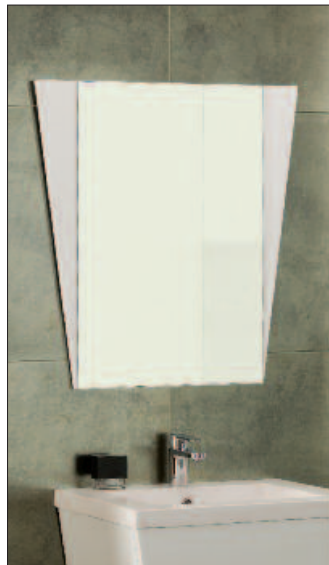

v line mirror



led light framed mirror



contemporary mirror



silhouette mirror

mirror cabinets

see retail price list for size options



glass back colour options

suitable for sliding door mirror cabinet

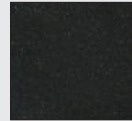

black starlight

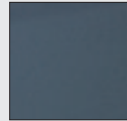

blue shadow



green sage



metal taupe



silver mirror

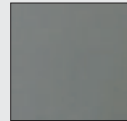

storm grey



sliding door mirror cabinet - door open



double sided mirror
full height cupboard



double sided mirror wall cupboard



standard mirror unit



deluxe mirror unit

mirror cabinets

see retail price list for size options



mirage wall cupboard

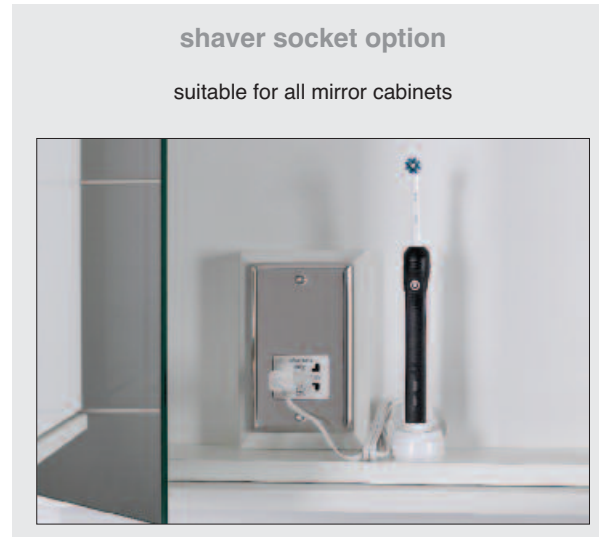

small angled double sided mirror unit

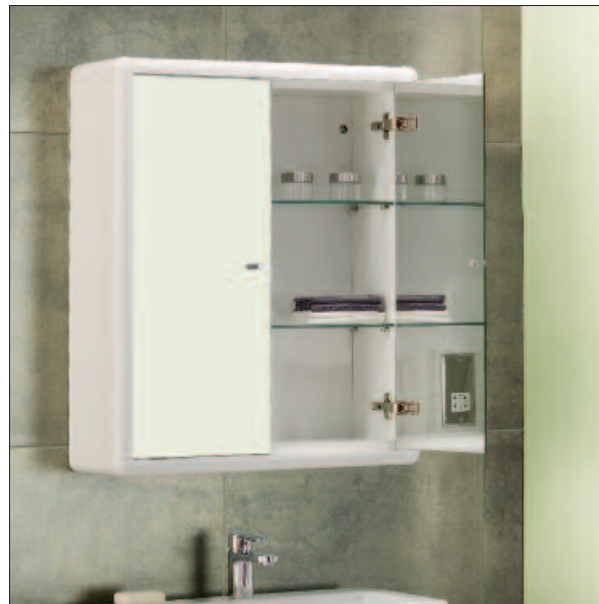

double sided mirror wall cupboard - curvature framing



salire mirror cabinet - includes LED lighting and USB socket

LED lighting



lighting: aquarius LED 240V, low energy LED intermediate panels & LED 10 light plinth kit

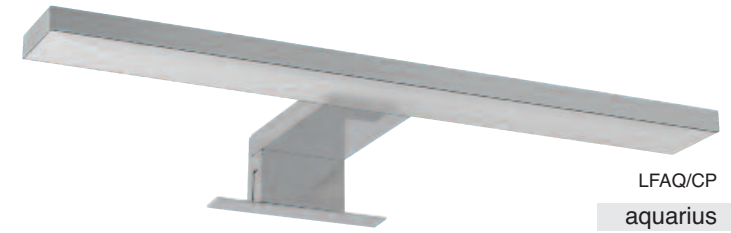

LFAQ/CP
aquarius
240V



LFLED/CP
downlight
low energy LED

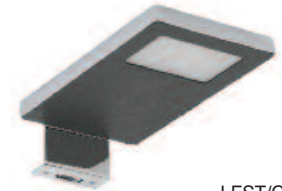

LFST/CP
strata
low energy LED

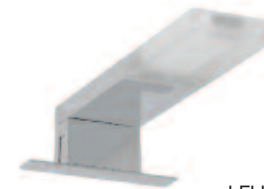

LFLU/CP
lux
240V



LFLUNA
luna
240V

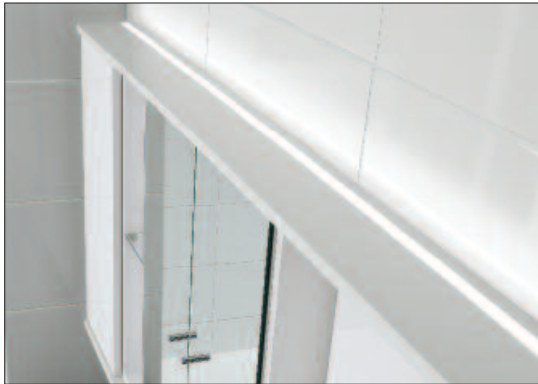

integrated LED - uppertop



integrated LED - undertop



integrated LED - plinth



all LED lights are low energy - upper, undertop & plinth supplied with LED strip & diffuser fitted

bath panels



deluxe bath panel

simple

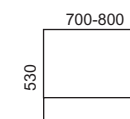
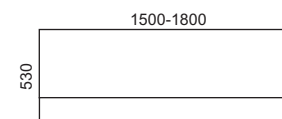

no doorstyle options,
single panel with
shadow groove

front panel

- 1500mm width BPSIM15
- 1600mm width BPSIM16
- 1700mm width BPSIM17
- 1800mm width BPSIM18

end panel

- 700mm width BPSIM70
- 750mm width BPSIM75
- 800mm width BPSIM80



panel
finishes
page 10



26

your choice - to bath panel shown

bath panels

standard



standard LED

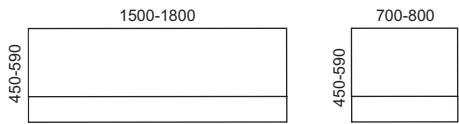
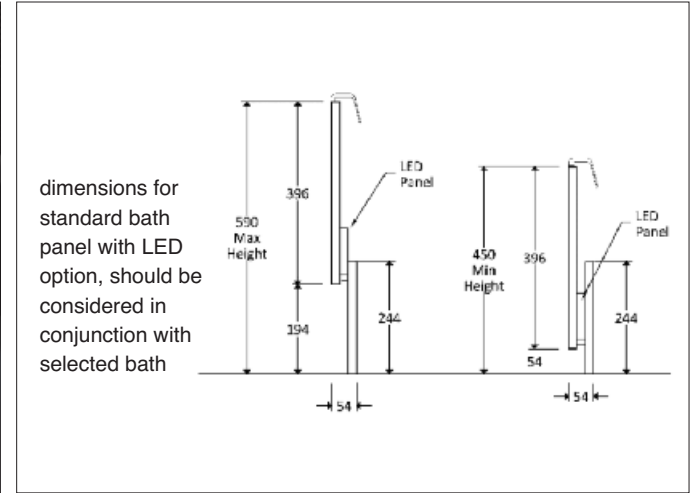

available to match doorstyles

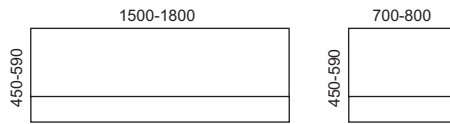

plinth provides height adjustability

front panel

- 1500mm width BPS15 (PR)
- 1600mm width BPS16 (PR)
- 1700mm width BPS17 (PR)
- 1800mm width BPS18 (PR)

end panel

- 700mm width BPS70 (PR)
- 750mm width BPS75 (PR)
- 800mm width BPS80 (PR)

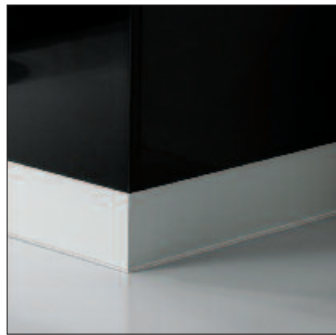

front panel

- 1500mm width BPS15LED (PR)
- 1600mm width BPS16LED (PR)
- 1700mm width BPS17LED (PR)
- 1800mm width BPS18LED (PR)

end panel

- 700mm width BPS70LED (PR)
- 750mm width BPS75LED (PR)
- 800mm width BPS80LED (PR)





Please add 'PR' for pressed plinth option

Please add 'PR' for pressed plinth option

panel finishes  page 10 **37**

panel styles  page 8 **7**

panel finishes  page 10 **37**

panel styles  page 8 **7**

your choices - to bath panels shown

bath panels



deluxe / deluxe offset - front panels removed

deluxe



deluxe offset



version shown left hand

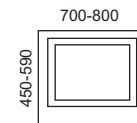
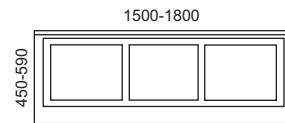

available to match doorstyles. fixed rear panel (trimmable) & removable front panel

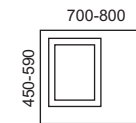
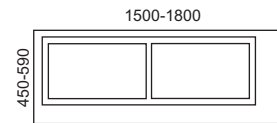

for use with fitted furniture installations

front panel

- 1500mm width BP15
- 1600mm width BP16
- 1700mm width BP17
- 1800mm width BP18

end panel

- 700mm width BP70
- 750mm width BP75
- 800mm width BP80



front panel

- 1500mm width BPO15
- 1600mm width BPO16
- 1700mm width BPO17
- 1800mm width BPO18

end panel

- 700mm width BPO70
- 750mm width BPO75
- 800mm width BPO80



panel finishes
page 10

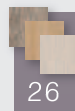

26

panel styles
page 8



6

panel finishes
page 10



26

panel styles
page 8



6

your choices - to bath panels shown

bath panels

storage



storage offset



version shown left hand

suitable bath dimensions for use of storage bath panel
not suitable for baths with rim supported tubular framework

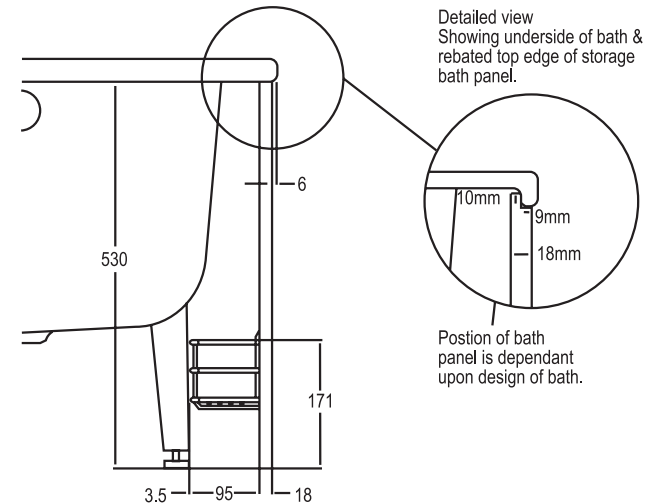
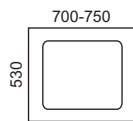
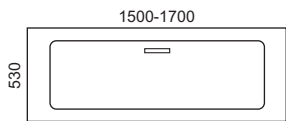
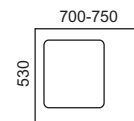
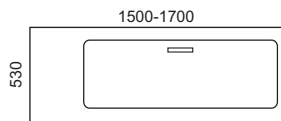

Diagram of a 700mm wide bath, that has legs with a width of 455mm. Panel height 530mm (plus rebate), not trimmable.



no doorstyle option
availability for
storage panels



for use with fitted
furniture installations
or where stand alone
items restrict opening

front panel

- 1500mm width BPSTOR15
- 1700mm width BPSTOR17

end panel

- 700mm width BPSTOR70
- 750mm width BPSTOR75



front panel

- 1500mm width BPSTOR15
- 1700mm width BPSTOR17

end panel

- 700mm width BPSTOR70
- 750mm width BPSTOR75



dedicated handle options - storage bath panel

panel finishes page 10 26
handle options pages 12-13 6

panel finishes page 10 26
handle options pages 12-13 6

worktops

laminite worktops

A hard wearing & highly water resistant worktop material, available in an attractive range of high gloss or natural texture finishes. Laminite worktops will be familiar to many customers already, as apart from being very attractive they provide both a practical & competitive solution.

high gloss finishes

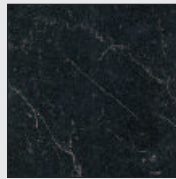

black marble

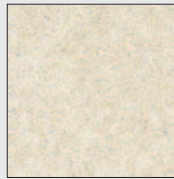

golden sparkle



grey cluster

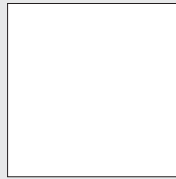

hi gloss white



night sparkle

please note some shade and pattern variation is possible

natural texture finishes

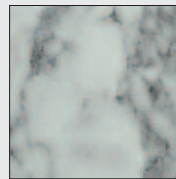

carrara marble

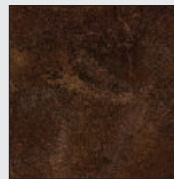

ceramic rust

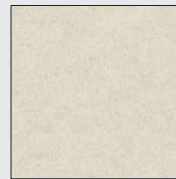

glitter bianco

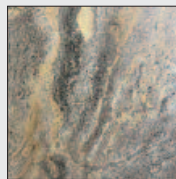

grey cipollino

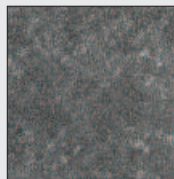

moonstone



textured black

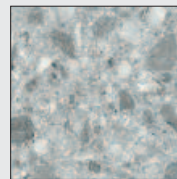

trebis stone

please note some shade and pattern variation is possible
please note some pattern variation is also possible when jointing marble / linear type finishes

laminite profile & ends

overall worktop thickness 28mm



laminite worktop
6mm/6mm front profile
with squared end

laminite worktop
6mm/6mm front profile

vinyl wrapped worktops

Allowing you to match the worktop finish perfectly, to the finish of your fronts (wood grain & soft), this worktop material remains a firm favourite. Couple this with the ability to form shapes & profile, features normally only available with more expensive worktop materials, wrapped worktops really are an interesting option.

vinyl wrapped finishes



argento beech

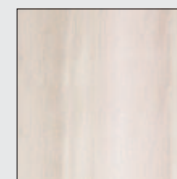

french oak

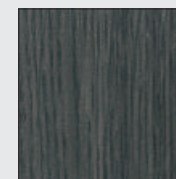

midnight oak

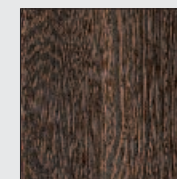

mali wenge
- textured



natural oak
- textured



nordic grey

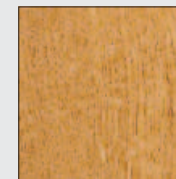

pippy oak



vintage oak
- textured

please note some shade and pattern variation is possible



cashmere elm



mussel elm



white elm

vinyl wrapped profile & ends

overall worktop thickness 25mm

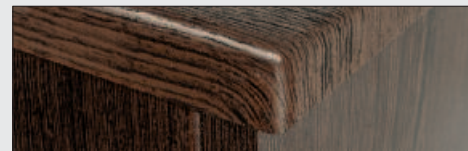

vinyl wrapped worktop: 5mm front profile
with profiled end



vinyl wrapped worktop: 5mm front profile
with squared end

vinyl wrapped matt, gloss & painted worktops

Colour co-ordination essential, matt, gloss & painted vinyl wrapped worktops are the answer, giving your furniture contemporary look.



matt finishes



blue indigo

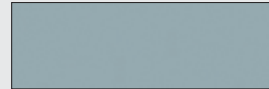

denim



light grey



stone



soft ivory



concrete - textured

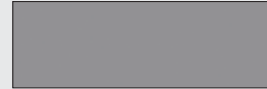

dust grey

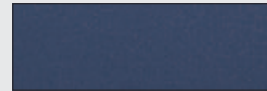

parisian blue



soft black



soft white

hi gloss finishes

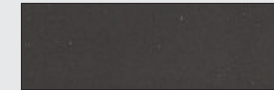

anthracite

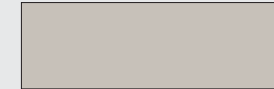

cashmere

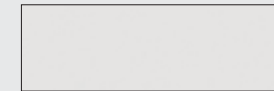

light grey



black

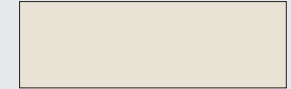

cream



white

choose your colour
matt and matt
grained vinyl

worktops to match
most popular paint finishes



vinyl wrapped profile & ends

overall worktop thickness 25mm



vinyl wrapped worktop: 5mm front profile with profiled end



vinyl wrapped worktop: 5mm front profile with squared end

neostone worktops

worktops & upstands neostone

Neostone solid surface worktops compliment our bathroom furniture perfectly. They are produced from a man made modified acrylic, its solid 12mm thickness make neostone a rather unique worktop material. Neostone worktops have the look and feel of natural granite but cut as easily as a standard laminate surface, great in a bathroom environment and easy to fit.

neostone finishes

12mm thickness

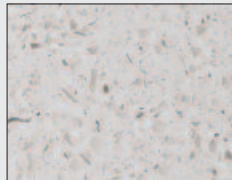

alaskan - quartz

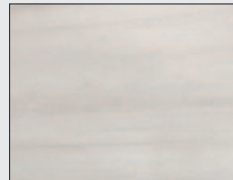

cafe crema - marble

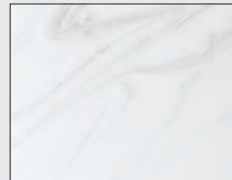

calacatta - marble

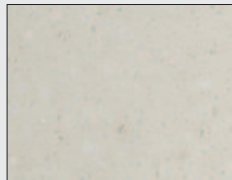

cotswold - stone

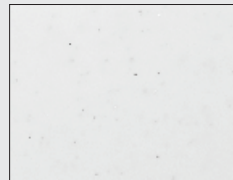

crystal - stone

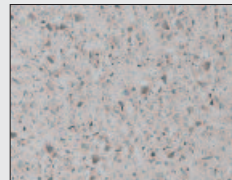

grey - quartz

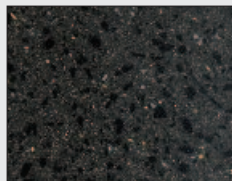

lava - stone



madison - mist

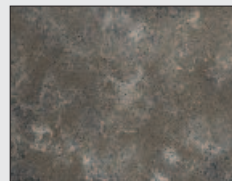

parisian - mist

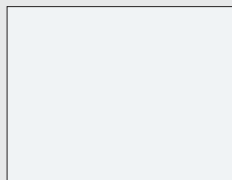

white - stone

please note some shade and pattern variation is possible - all finishes, also possible when jointing marble / linear type finishes

neostone profile & ends



neostone worktop: 5mm front profile with profiled end

neostone profile & ends

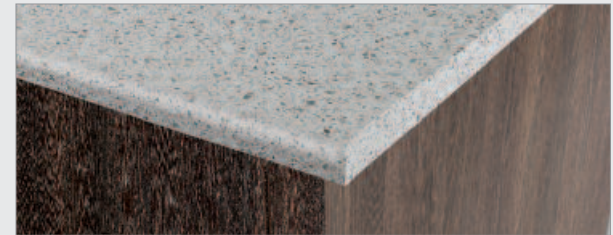

neostone worktop: 5mm front profile with profiled end

overall worktop thickness **12mm**

neostone worktop: 5mm front profile with squared end



worktop shaping now available for D line and S line units

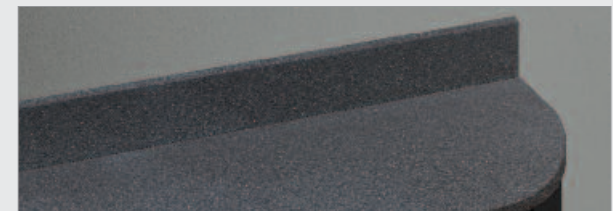

12mm plant on upstand 100mm or 200mm height, profile top



neostone worktop features

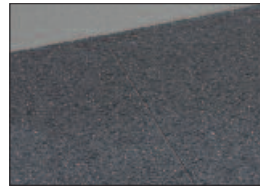

butt joint

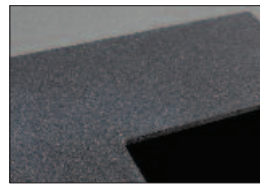

cut back

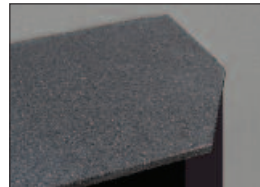

angled end



curved end



round bowl
worktop finish: lava lustre
bowl finish: white *

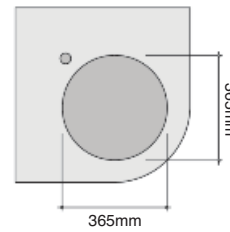

rectangular bowl
worktop finish: lava lustre
bowl finish: white *

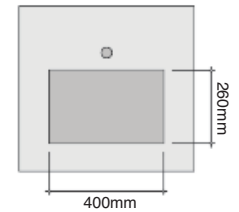

inline bowl
worktop finish: lava lustre
bowl finish: white *

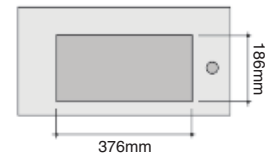

diagrams show internal bowl dimensions



oval bowl - large
worktop finish: lava lustre
bowl finish: white *

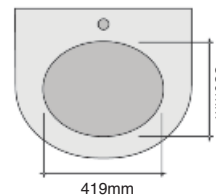

oval bowl - small
worktop finish: lava lustre
bowl finish: white *

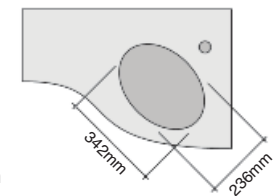

* bowls available only in white finish



Corian® is the original solid surface material. Created to last a lifetime it is a unique blend of minerals and acrylic which creates a stone-hard surface that can be shaped to meet any design or dimension.

overall worktop thickness 25mm or 12mm (both use 12mm Corian sheet in construction).

corian finishes - luxe

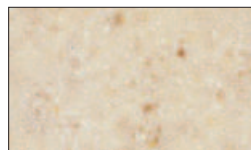

aurora



glacier

please note some pattern variation is also possible when jointing marble / linear type finishes

corian finishes - premium



carbon aggregate

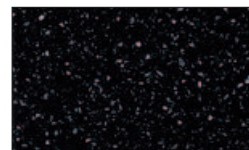

deep black quartz



everest



grey onyx

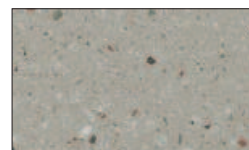

willow



witch hazel

please note some shade and pattern variation is possible - all finishes



integrated white corian oval bowl, worktop with cut back

worktop finish: aurora



rectangular bowl worktop: everest, bowl: glacier

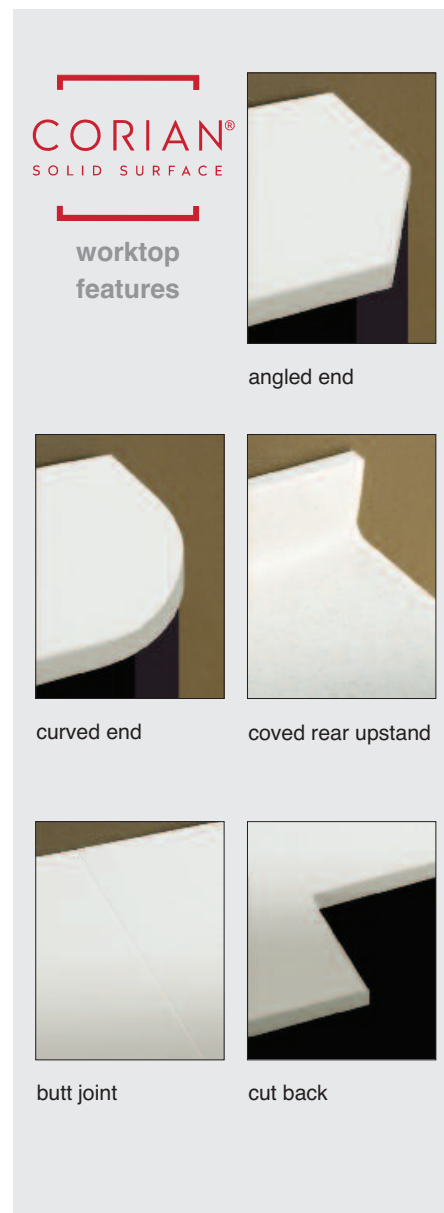

worktop features

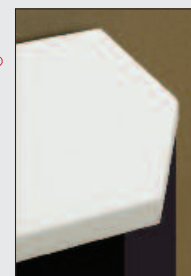

angled end

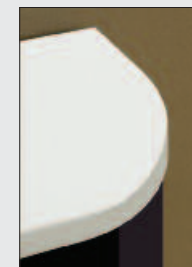

curved end

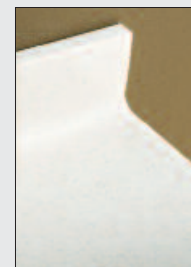

coved rear upstand

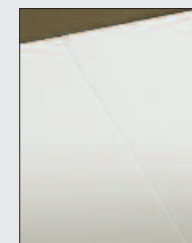

butt joint



cut back

CORIAN® profile & ends
SOLID SURFACE

overall worktop thickness
12mm or 25mm



5mm front profile with profiled end
- 12mm thickness worktop



5mm front profile with square end
- 25mm thickness worktop

CORIAN® bowl options
SOLID SURFACE

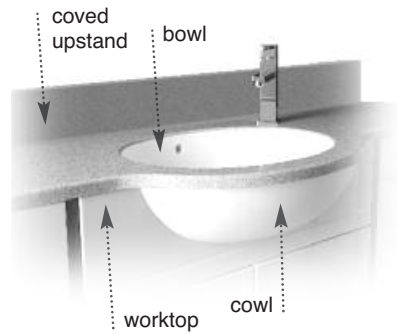

internal bowl dimensions

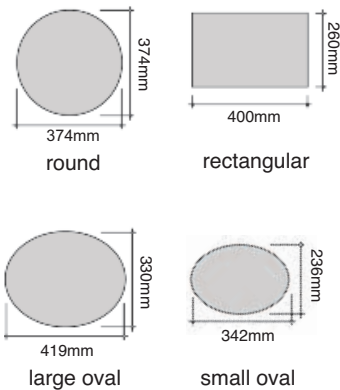

bowls integrated into corian worktops



semi-recessed rectangular bowl
worktop & cowl finish: everest bowl finish: glacier



semi-recessed oval bowl *small and large versions available*
worktop finish: willow bowl & cowl finish: glacier



small oval bowl (S line unit)
worktop finish: everest bowl finish: glacier



large oval bowl (D line unit)
worktop & bowl finish: glacier



natural texture - slate
effect finish options

slate -
black

slate -
cement

slate -
oyster

slate -
white

NTX – Natural Texture countertop basins & shower trays, are produced from a compound of polyurethane and mineral fillers, which are compacted to achieve a solid finish. The resulting material has excellent forming properties, allowing the production of the high quality slate effect finish, whilst also providing an exceptionally high resistance to hydrolysis, impact & thermal variance.

one piece slate effect countertops,
with smooth finish colour matched basins

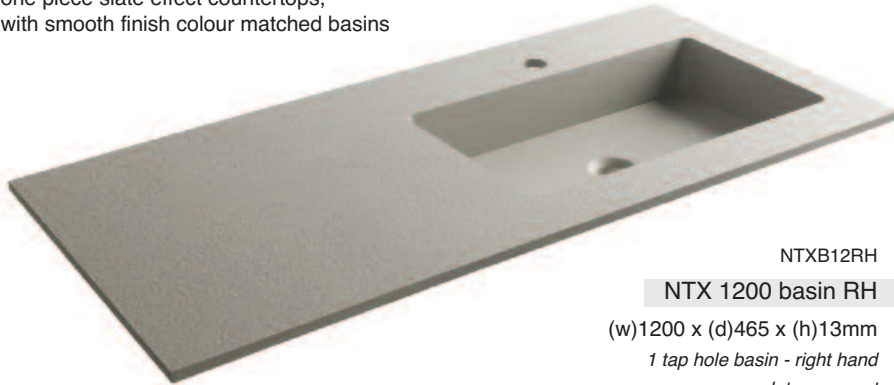

NTXB12RH

NTX 1200 basin RH

(w)1200 x (d)465 x (h)13mm

1 tap hole basin - right hand
slate - cement

one piece slate effect shower tray, slip
resistance & angled finish for optimum drainage

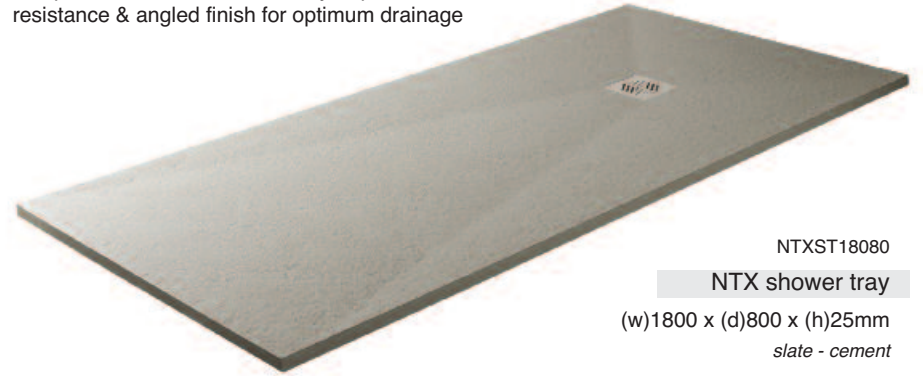

NTXST18080

NTX shower tray

(w)1800 x (d)800 x (h)25mm

slate - cement

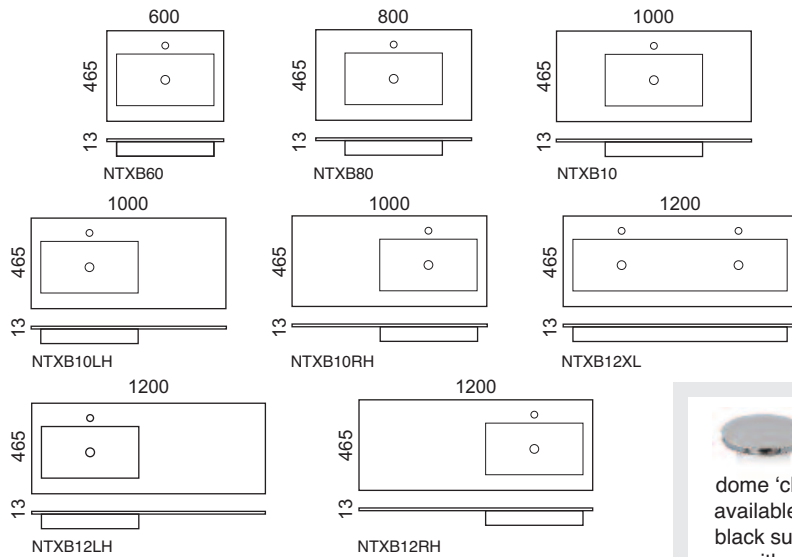

dome 'click clack' waste
available chrome & matt
black supplied complete
with compact trap

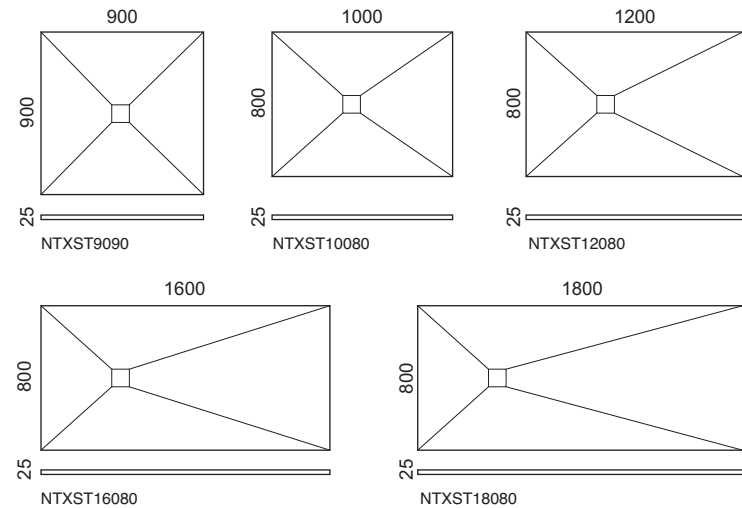

Tray thickness - minimum 21mm, maximum 25mm

product features



antibacterial
certified



thermal shock
resistant



hydrolysis
resistant



impact
resistant



easy to cut
shower trays



antislip
shower trays

gelcast basins



standalone installations



G61SLBS



G6143

all gelcast basins can be used either standalone or as part of inline installation

inline installations



G61SLB

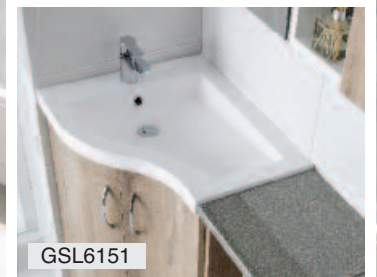

GSL6151

gelcast basins

all gelcast basins can be used either standalone or as part of inline installation

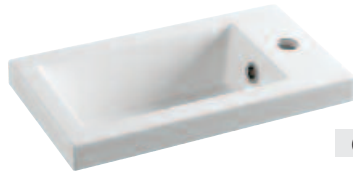

G4623

gelcast (w)460 x (d)235mm
1 tap hole basin - left hand
left or right hand installation

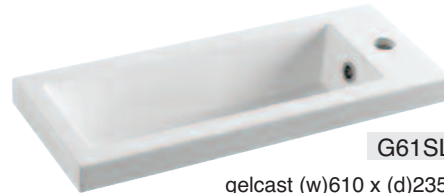

G61SLBS

gelcast (w)610 x (d)235mm
1 tap hole basin - left hand
left or right hand installation



G8143

gelcast (w)810 x (d)430mm
1 tap hole basin
available no tap hole - please add 'NT' to code

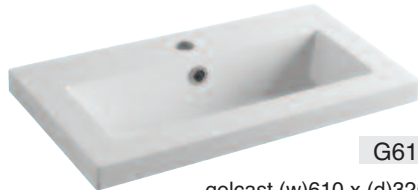

G61SLB

gelcast (w)610 x (d)325mm
1 tap hole basin



G6143

gelcast (w)610 x (d)430mm 1 tap hole basin
available no tap hole - please add 'NT' to code

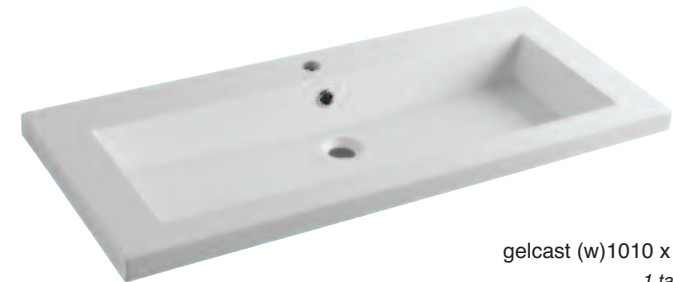

G1043

gelcast (w)1010 x (d)430mm
1 tap hole basin
available no tap hole - please add 'NT' to code



GD6143

gelcast (w)610 x (d)430mm 1 tap hole basin



GD6152

gelcast (w)610 x (d)520mm 1 tap hole basin



GSR6142

gelcast (w)610 x (d)420mm 1 tap hole basin - right hand
left hand version also available GSRL6142



GSR6151

gelcast (w)610 x (d)510mm 1 tap hole basin - right hand
left hand version also available GSL6151

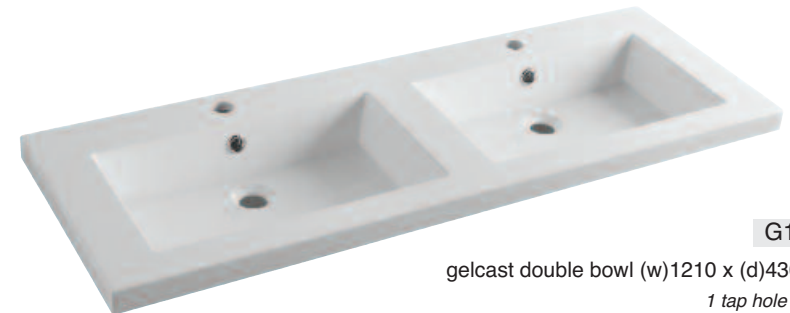

G1243

gelcast double bowl (w)1210 x (d)430mm
1 tap hole basin
available no tap hole - please add 'NT' to code

c e r a m i c

standalone installations



all Indigo ceramic basins can be used either standalone or as part of inline installation

inline installations



SR46BS

uni semi-recessed

(w)460 x (d)320 x (h)160mm 1 tap hole basin - right hand



SR54BPS

uni semi-recessed

(w)540 x (d)400 x (h)160mm 1 tap hole basin



SR52BS

uni semi-recessed

(w)520 x (d)260 x (h)140mm 1 tap hole basin - right hand only

uni ceramic basins & wc



indigo ceramic
(w)600 x (d)450 x (h)45mm 1 tap hole basin
available with Indigo basin units



uni ceramic
(w)620 x (d)470 x (h)17mm 1 tap hole basin



SO32B
podium sit on
(w)320 x (d)320 x (h)130mm 0 tap hole basin

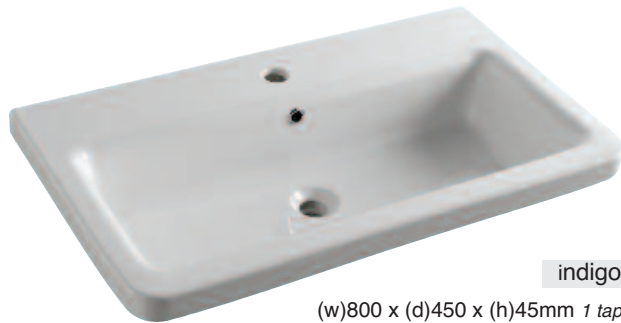

indigo ceramic
(w)800 x (d)450 x (h)45mm 1 tap hole basin
available with Indigo basin units



uni ceramic
(w)820 x (d)470 x (h)17mm 1 tap hole basin



matteo ceramic
(w)340 x (d)300 x (h)130mm 1 tap hole basin
available with Matteo basin units



uni ceramic
(w)1020 x (d)470 x (h)17mm 1 tap hole basin

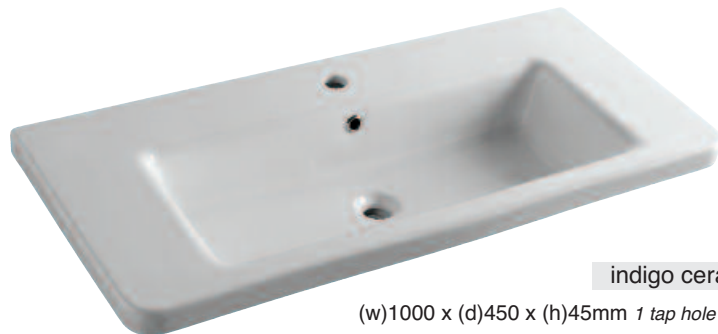

indigo ceramic
(w)1000 x (d)450 x (h)45mm 1 tap hole basin
available with Indigo basin units

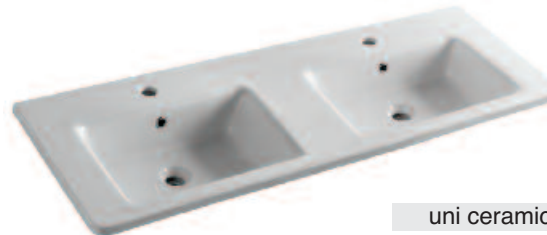

uni ceramic
(w)1220 x (d)470 x (h)17mm 2 tap hole basin



BTWC3COMP
uni back to wall wc suite
(w)360 x (h)450 x (d)520mm with rimless pan design

ceramic wc's

  <p>BTWC2COMP diversity back to wall wc suite (w)345 x (h)420 x (d)520mm</p>	   <p>BTWC4COMP altitude comfort height back to wall wc suite (w)360 x (h)450 x (d)520mm <i>with rimless pan design</i></p>	 <p>CCWCSCOMP ovi close coupled wc suite (w)355 x (h)760 x (d)615mm</p> 
  <p>WHWC2COMP diversity wall hung wc suite (w)360 x (h)360 x (d)500mm</p>	  <p>WHWCCOMP ovi wall hung wc suite (w)360 x (h)360 x (d)500mm</p>	
 <p>all of our WC's include a cushion closure seat as standard</p>	  <p>BTWCCOMP ovi back to wall wc suite (w)345 x (h)420 x (d)500mm</p>	

ceramic basins



SR55B

ovi semi-recessed

(w)550 x (d)450 x (h)140mm 1 tap hole basin



SR56B

diversity semi-recessed

(w)560 x (d)420 x (h)150mm 1 tap hole basin



S2C50B

stadium 2 ceramic

(w)500 x (d)395 x (h)15mm 1 tap hole basin



incline

(w)550 x (d)450 x (h)140mm 1 tap hole basin
available with incline basin units



SO50B

sit on

(w)500 x (d)410 x (h)135mm 1 tap hole basin



SR50BSALT

altitude semi-recessed

(w)500 x (d)380 x (h)175mm
1 tap hole basin - right hand



SR56BALT

altitude semi-recessed

(w)560 x (d)430 x (h)175mm
1 tap hole basin



S2C60B

stadium 2 ceramic

(w)600 x (d)460 x (h)15mm 1 tap hole basin



stadium 2 ceramic



retail price list & installation dimensions

Please ask your Montrose dealer for a copy of our separate *Retail Price List & Installation Dimensions*



or go on-line to the Montrose website
www.montrosefurniture.co.uk

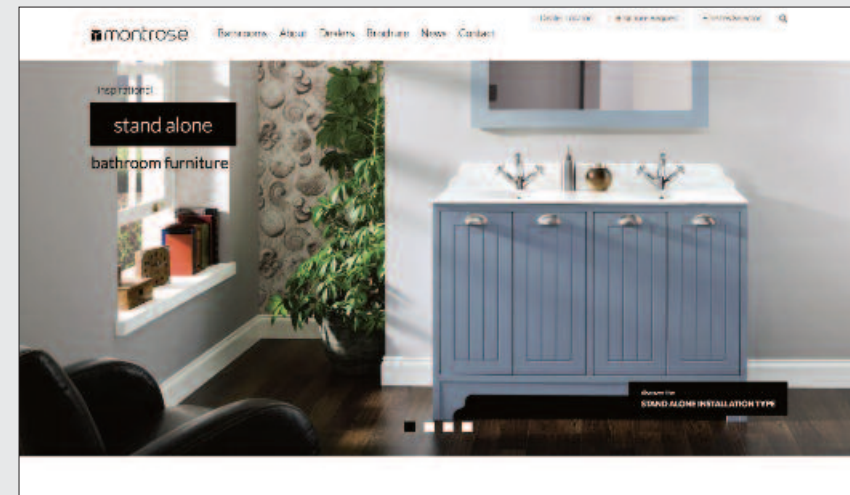

& enter link

www.montrosefurniture.co.uk/brochure/retail-price-list
to view or download a PDF copy now

Should your dealer not have a copy to hand, please contact us directly

enquiries@montrosefurniture.co.uk

we will be happy to forward one by email or via the post



Alternatively, use your smartphone & this QR Code to access directly





Montrose Furniture makes the most of your home's available space and will fit perfectly with your family's lifestyle, now and for many years to come.





montrose



inspirational bathroom furniture

MONTROSE FURNITURE LTD:

Head Office & Factory, Paycocke Road, Basildon, Essex SS14 3NW

Tel: 01268 476800

enquiries@montrosefurniture.co.uk

www.montrosefurniture.co.uk



**WORLD
LAND
TRUST™**

www.carbonbalancedpaper.com
CBP00064081710131730

This brochure has been produced using FSC sourced paper. By using FSC sourced paper we are helping to support responsible forestry and paper manufacture, both in the UK and abroad.

The colours in this brochure are as accurate as printing processes allow. Colours and shades may vary. Our policy is one of continuous improvement, we reserve the right to amend designs and specifications without prior notice.